

SIEMENS



SENTRON

3WT Air Circuit Breakers up to 4000 A

Catalog
LV 35

Edition
2019

[siemens.com/lowvoltage](https://www.siemens.com/lowvoltage)

Related catalogs

Low-Voltage Power Distribution and Electrical Installation Technology LV 10
 SENTRON • SIVACON • ALPHA
 Protection, Switching, Measuring and Monitoring Devices, Switchboards and Distribution Systems

PDF (E86060-K8280-A101-A8-7600)
 Print (E86060-K8280-A101-A6-7600)



Air Circuit Breakers and Molded Case Circuit Breakers with UL Certification LV 18
 SENTRON

PDF (E86060-K8280-E347-A1-7600)



Industrial Controls IC 10
 SIRIUS

PDF (E86060-K1010-A101-A9-7600)



Industrial Communication IK PI
 SIMATIC NET

E86060-K6710-A101-B8-7600



DELTA ET D1
 Switches and Socket Outlets

PDF



SITRAIN
 Training for Industry

www.siemens.com/sitrain



Catalog PDF / Contact

Catalog PDF

Digital versions of the catalogs are available in the Siemens Industry Online Support.

www.siemens.com/lowvoltage/catalogs



Contact

Your personal contact can be found in our Contacts Database at:

www.siemens.com/automation-contact



Industry Mall / TIA ST / CA 01

Industry Mall

Information and Ordering Platform on the Internet:

www.siemens.com/industrymall



Siemens TIA Selection Tool

for the selection, configuration and ordering of TIA products and devices

www.siemens.com/tst



Products for Automation and Drives CA 01

Interactive Catalog Download

www.siemens.com/ca01download



Trademarks

All product designations may be registered trademarks or product names of Siemens AG or other supplying companies. Third parties using these trademarks or product names for their own purposes may infringe upon the rights of the trademark owners. Further information about low-voltage power distribution and electrical installation technology is available on the Internet at:

www.siemens.com/lowvoltage

Technical Support

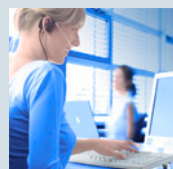

Expert advice on technical questions with a wide range of demand-optimized services for all our products and systems.

www.siemens.com/lowvoltage/support-request

3WT Air Circuit Breakers up to 4000 A

SENTRON



Catalog LV 35 · 2019

Supersedes:
Catalog LV 35 · 2017

Please contact your local Siemens branch.

© Siemens AG 2019

Introduction

1

3WT Air Circuit Breakers up to 4000 A (AC)

2

Appendix

3



As a source of energy for industry, buildings and infrastructures, the reliability of the power supply is becoming ever more important. Only a flexible power supply tailored to every individual scenario can meet all individual challenges, while at the same time increasing availability and profitability.

Totally Integrated Power (TIP) from Siemens is a holistic, customizable power supply solution comprising software and hardware products, systems and solutions across all voltage levels. The systems and products of the TIP portfolio can be integrated seamlessly into industrial and building automation systems. TIP enables companies to focus on their core business and simultaneously ensure a reliable, secure and efficient supply of power. Because "power matters".

Electrical power distribution – integrated, safe and efficient

The increasing level of automation in buildings and industry introduces novel requirements for electrical power distribution and makes the underlying technologies ever more complex. Our components and systems are perfect for integration into networked environments, and they significantly contribute toward increasing the efficiency of your business processes. Communication-capable, flexible and fail-safe devices combine with digital engineering to provide you with optimized solutions – for any application.

Comprehensive portfolio

Our products lay the foundations for safe, reliable and efficient electrical infrastructure at medium and low-voltage levels in buildings, infrastructure and industrial applications. Our portfolio includes, among other devices, power distribution boards and distribution boards, communication-capable protection, switching, measuring and monitoring devices, as well as switches and socket outlets. Our tested and certified components, systems and software packages allow for ever-suitable solutions in both centralized and distributed power systems the world over. They reliably protect against accidents, faults and fires caused by electrical installations and allow consumers to utilize electrical power in a sustainable, responsible manner.

Simplified engineering

We support you throughout the entire value chain – from the planning stage, during installation and right through to operation, as well as when it comes to measures for modernizing and expanding your electrical power distribution systems. You benefit from a broad portfolio of personalized and online-based maintenance and support services. Professional software and data ensure simple planning in compliance with standards as well as error-free configuration and documentation. Clear ordering channels, transparent product availability data and high delivery reliability coupled with swift global spare part provision, comprehensive online services, expert consulting and fast, efficient and reliable processes ensure that you are optimally covered throughout the entire product life cycle.

Notes

Introduction



1/2

3WT air bircuit breakers

For further technical product information:

Siemens Industry Online Support:
www.siemens.com/lowvoltage/product-support

→ Entry type:
Application example
Certificate
Characteristic
Download
FAQ
Manual
Product note
Software archive
Technical data

Introduction

3WT air circuit breakers

1

Overview

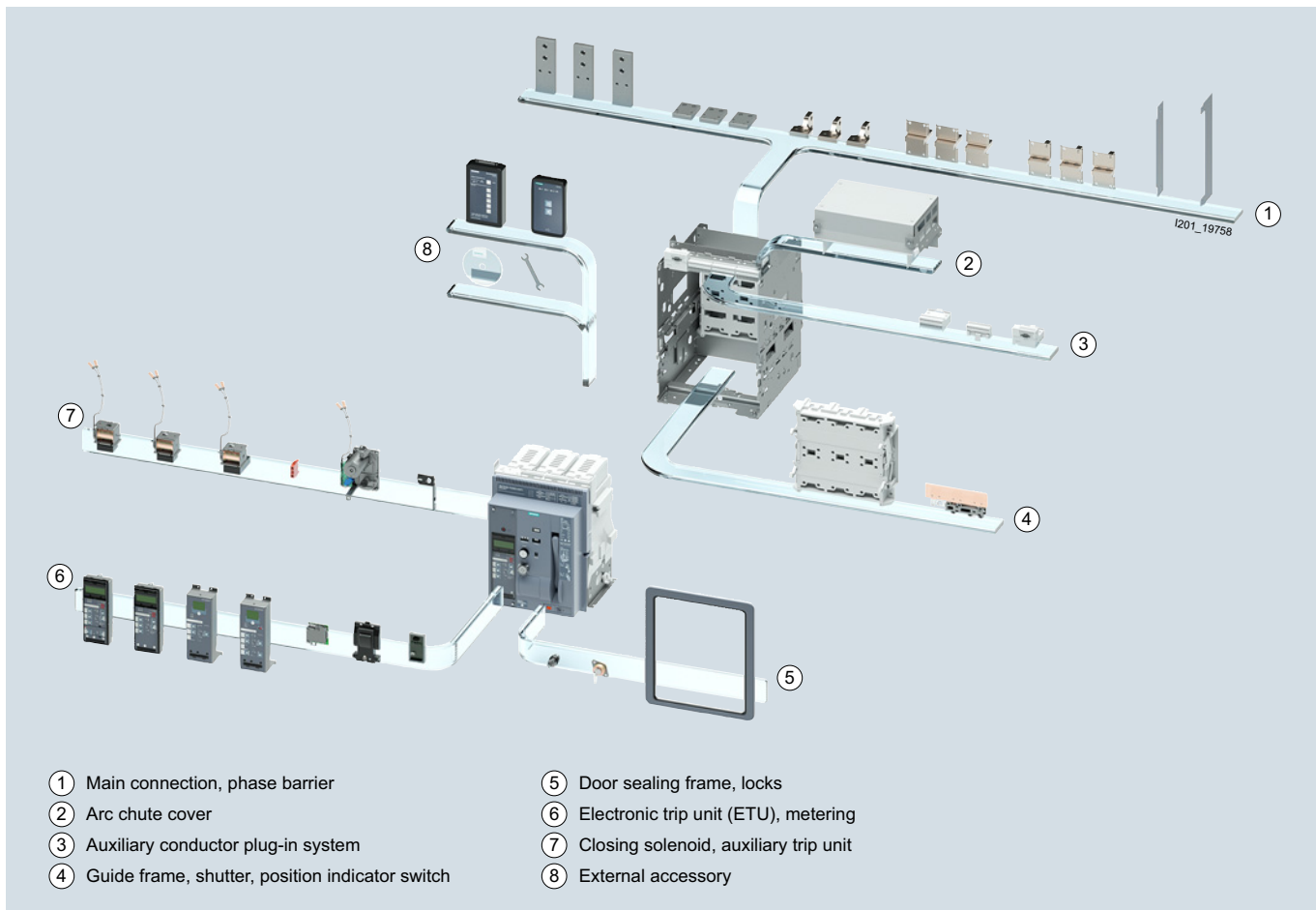

Benefits

Flexibility

- Electronic trip units (ETU) with outstanding features
- Only two frame sizes cover a broad range of applications from 400 A to 4000 A, with a breaking capacity up to 66 kA up to 690 V, 3- or 4-pole version, fixed-mounted, withdrawable version
- Modbus RTU communication
- Metering with internal voltage tap
- All components can be combined in a modular way

Ease of use

- User friendliness in planning, configuration, installation and operation
- Wide range of accessories for both frame sizes can be easily retrofitted
- Displays for all electronic trip units (ETU)

Safety and reliability

- International and standardized processes ensure highest product quality
- Conforms to international standards and approvals

Introduction

Notes

1

3WT Air Circuit Breakers up to 4000 A (AC)



2/2	General data
2/17	3- and 4-pole, withdrawable version inclusive standard accessories
2/18	3- and 4-pole, fixed-mounted version inclusive standard accessories
2/19	3- and 4-pole, withdrawable version
2/22	3- and 4-pole, fixed-mounted version
2/23	Non-automatic air circuit-breakers, 3- and 4-pole, withdrawable version
2/24	Non-automatic air circuit-breakers, 3- and 4-pole, fixed-mounted version
2/25	Options NEW
2/32	Accessories/spare parts NEW
2/36	Project planning aids

For further technical product information:

Siemens Industry Online Support:
www.siemens.com/lowvoltage/product-support

→ Entry type:
 Application example
 Certificate
 Characteristic
 Download
 FAQ
 Manual
 Product note
 Software archive
 Technical data

3WT Air Circuit Breakers up to 4000 A (AC)

General data

Overview

2

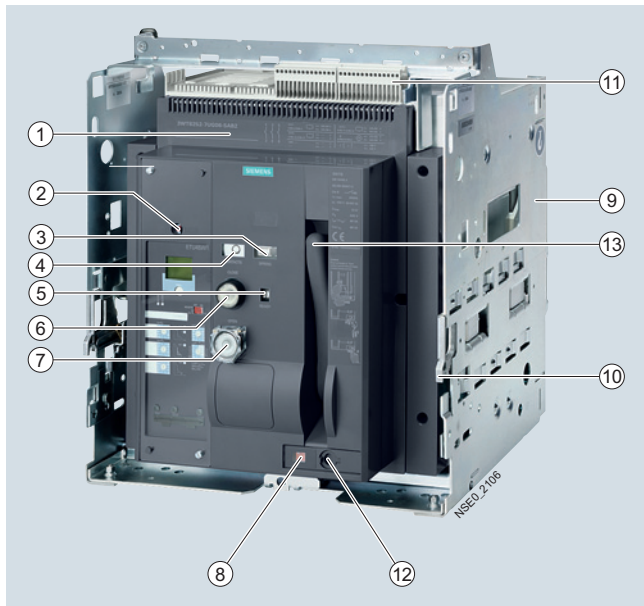

3WT circuit breaker, withdrawable version, size II, 3-pole

3WT circuit breaker, fixed-mounted version, size II, 3-pole

- ① Withdrawable circuit breaker
- ② Indication and reset button after tripping for
– tripped signaling switch and
– manual reset reclosing lockout
- ③ Stored-energy indicator
- ④ Switching position indicator
- ⑤ Ready-to-close indicator
- ⑥ ON button, mechanical
- ⑦ OFF button, mechanical
- ⑧ Indication of circuit breaker position
- ⑨ Guide frame
- ⑩ Guide rails
- ⑪ Auxiliary circuit plug-in system
- ⑫ Crank hole
- ⑬ Hand lever

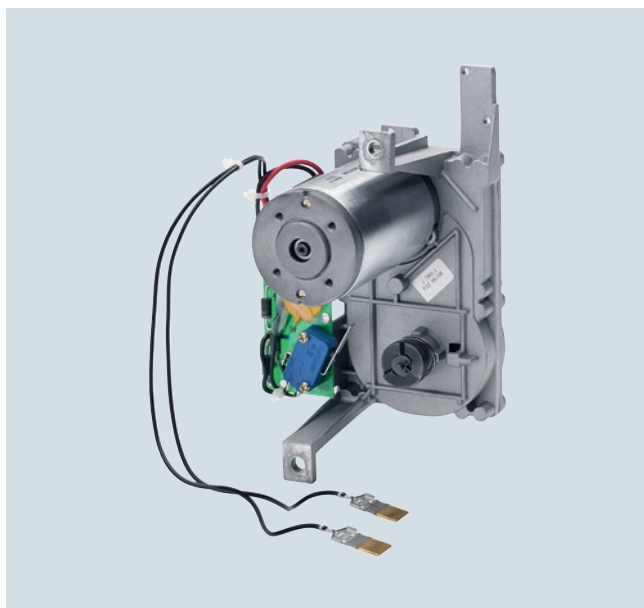

Motorized operating mechanism

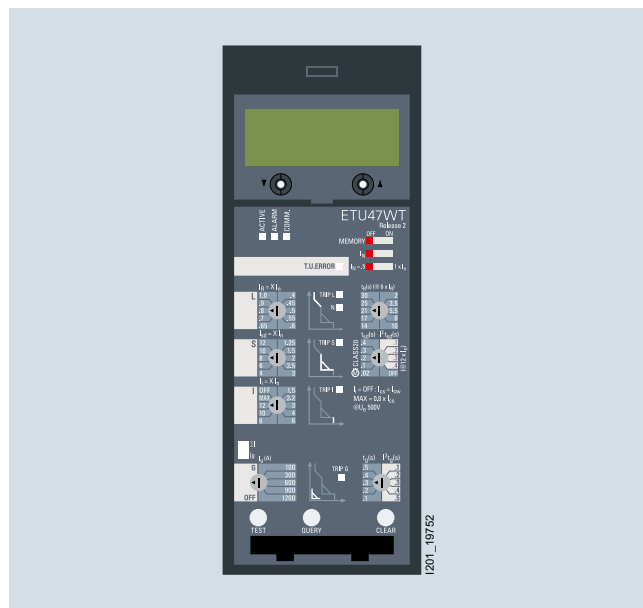

Electronic trip unit

Benefits**Safety and reliability**

- High degree of protection with door sealing frame in the case of exclusively local operation of the circuit breaker
- Infeed supply from above or below, as required
- Locking of the withdrawable circuit breaker against moving, as standard
- Locking of the guide frame with the circuit breaker removed, as standard
- Signaling switch for overload and short-circuit tripping with mechanical reclosing lockout
- High degree of protection with cover IP55
- Mechanical reclosing lockout after overload or short-circuit tripping as standard
- The circuit breaker is always equipped with the required number of auxiliary supply connectors

Easy to operate

- Unambiguous ON-OFF indicator with auxiliary switch for signal
- Ready-to-close indicator with signaling switch as safety standard.

Modular

Many components, such as auxiliary releases, motorized operating mechanisms, electronic trip units and current transformers can be replaced or retrofitted to adapt the circuit breaker to changing requirements.

Minimal power loss and therefore low energy consumption

The low power consumption of the electrical components also saves money when it comes to purchasing the control-power transformers. Where space is at a premium or ventilation is limited.

Application

IEC 60947-2,
GB 14048.2,
CCC approval,
climate-proof to IEC 60068-2-30, IEC 60068-2-6, Fc

Operating conditions

The 3WT circuit breakers are climate-proof in accordance with IEC 60068-2-30, IEC 60068-2-6, Fc.

They are intended for use in enclosed areas where no severe operating conditions (e.g. dust, corrosive vapors, damaging gases) are present.

When installed in dusty or damp areas, suitable enclosures must be provided. If damaging gases (e.g. hydrogen sulfide) are present in the surrounding air, sufficient incoming fresh air must be supplied.

The permissible ambient temperatures and the associated rated currents are listed in the technical specifications.

Design**Versions**

Breaking capacity: 55/66kA at 500V/690V
Rated current: from 400 A to 4000 A
Rated operating voltage: up to AC 690V

The 3WT circuit breakers are supplied complete with an operating mechanism, electronic trip unit and auxiliary switches and are fitted with auxiliary releases.

The non-automatic circuit breakers are supplied without electronic trip unit

Standard version

- Electronic trip unit with LSI protection, LCD display with backlight, LEDs for the cause of tripping, LED status indicator, query and test button
- Auxiliary supply connector: The circuit breaker is equipped with the required number of connectors
- Mechanical ON and OFF pushbutton
- Door sealing frame IP41
- Tripped signaling switch (1 NO)
- Ready-to-close indicator with signaling switch
- Stored-energy indicator
- Auxiliary switches (2NO + 2NC)
- Rear horizontal main circuit connections for fixed mounted and withdrawable versions
- For 4-pole circuit breakers, the fourth pole (N) is installed on the left and is 100 % loadable
- Indication and reset button after tripping for
 - tripped signaling switch and
 - mechanical reclosing lockout
- User manual in English/Chinese/Spanish/Portuguese/Turkish

Additional features of the withdrawable version:

- Main contacts: Laminated receptacles in the guide frame, penetration blades on the withdrawable circuit breaker
- Position indicator in the control panel of the withdrawable circuit breaker
- Guide frame with guide rails for easy moving of the withdrawable circuit breaker
- The withdrawable circuit breaker can be locked to prevent it being pushed out of position

Standard version for non-automatic circuit breaker

- Same features as the circuit breaker, see "Standard version" but
- No electronic trip unit

3WT Air Circuit Breakers up to 4000 A (AC)

General data

Function

Operating mechanisms (see illustration "Motorized operating mechanism")

The circuit breakers are available with various optional operating mechanisms:

- Manual operating mechanism with memory, with mechanical closing
- Manual operating mechanism with mechanical and electrical closing
- Motorized operating mechanism that can also be operated manually, with mechanical and electrical closing.

The operating mechanisms with electrical closing can be used for synchronization tasks.

EMERGENCY-STOP facility

The 3WT circuit breakers can be used as an EMERGENCY-STOP facility to IEC 60204-1 if the circuit breaker is equipped with an undervoltage release and is used in conjunction with an EMERGENCY-STOP control device.

Auxiliary and signaling switches

- Ready-to-close
If all the conditions are fulfilled, so that the circuit breaker is ready to close, this is indicated visually on the operator panel.
- The circuit breakers are supplied with 2 NO and 2 NC contacts or with 2 NO and 2 NC and 2 CO contacts or 4 NO and 4 NC contacts or 5 NO and 3 NC or 6 NO and 2 NC contacts according to order.
- "Tripped" signaling switch and mechanical reclosing lockout
As standard, the circuit breaker is equipped with an S11 signaling switch and a mechanical reclosing lockout for the common overload and short-circuit signal and, depending on the setting and version of the electronic trip unit, the ground-fault signal.
The tripped signal and the standard mechanical mechanism to prevent closing remain active until the reset button is operated on the circuit breaker. When the circuit breaker has tripped, this is indicated by the protruding reset button.
The electrical signal from the „tripped“ switch S11 has to be reset by operating the Reset button.

Auxiliary supply connections

The type of connection for the auxiliary switches depends on the type of installation:

- Withdrawable version:
The internal auxiliary switches are connected to the male connector on the circuit breaker side. When fully inserted, the connector makes a connection with the sliding module in the guide frame.
- Fixed mounting:
In this case the auxiliary supply connectors are engaged directly onto the circuit breaker.

Fixed-mounted and withdrawable version

Fixed-mounted and withdrawable circuit breakers

- Protective measures against arcing gases
For 3WT circuit breakers with voltages up to AC 690 V, screening from vertical busbars is not necessary. Electrical add-on devices on the side of the circuit breaker must be separately covered. Also see notes under "Project planning aids", "Dimensional drawings".
- Operator panel
The operator panel is designed to protrude from a cutout in the door providing access to all operator controls and displays with the door closed.
The operator panels for all circuit breakers (fixed-mounted/withdrawable versions, 3-pole, 4-pole) are identical. The operator panel ensures degree of protection IP41.
- Door sealing frame
The door sealing frame seals the cabinet door with the operator panel. With the cabinet door closed, the IP degree of protection is achieved for the circuit breaker.

Withdrawable circuit breaker

The withdrawable version comprises a withdrawable circuit breaker, a guide frame and a hand crank for moving the withdrawable circuit breaker. The guide frames are fitted with guide rails as standard for easy handling of the withdrawable circuit breaker.

- Auxiliary supply connections
The auxiliary supply connections make contact automatically when the circuit breaker slides into the guide frame (test position, connected position).
- Circuit breaker positions in the guide frame
The withdrawable version has three switch positions in the switchgear cabinet behind the cabinet door:
 - Connected position
(main circuit and auxiliary circuit ready)
 - Test position
(main circuit disconnected, auxiliary circuit ready)
 - Disconnected position
(main circuit and auxiliary circuit disconnected)

In the disconnected position, the withdrawable circuit breaker complies with the "protective separation condition" with a visible isolating distance in the main circuit and auxiliary circuit. The circuit breaker must always be switched off before it is moved. The "OFF" button must be held down when the slide in the crank hole is opened.

Guide frames

Closing of the crank hole is only possible in the circuit breaker positions (connected, test or disconnected position). The circuit breaker position is shown on a display on the circuit breaker.

The circuit breaker is moved with the help of a hand crank. The connected position as well as the disconnected position is achieved by moving the circuit breaker to the end stop.

- **Shutters**
Inadvertent touching of live main contacts or busbars is prevented by covering with a shutter. The shutter is constructed in two parts and allows the upper or lower connection areas to be opened separately for the purpose of checking that they are not live. The divided shutter can be interlocked in the open or closed position and two padlocks can be fitted.

Main circuit connections

All circuit breakers are equipped with horizontal main circuit connections on the rear for up to 3200 A as standard (horizontal connection to busbars). Exception: Circuit breakers of size II with max. rated current 4000 A. They are equipped with vertical main connections (for upright busbars).

The following options are available, with combinations of top and bottom connections possible:

- Accessible from the front, double hole (holes according to DIN 43673) (for vertically installed busbars)
- At the rear, vertical (for vertically installed busbars)

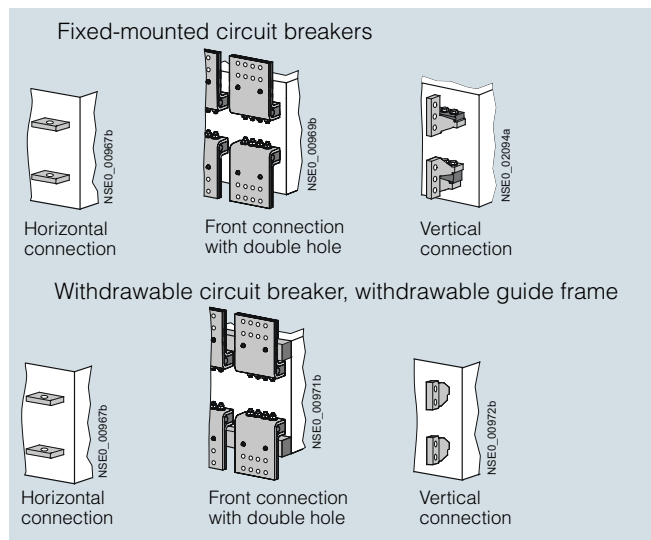

Main circuit connections

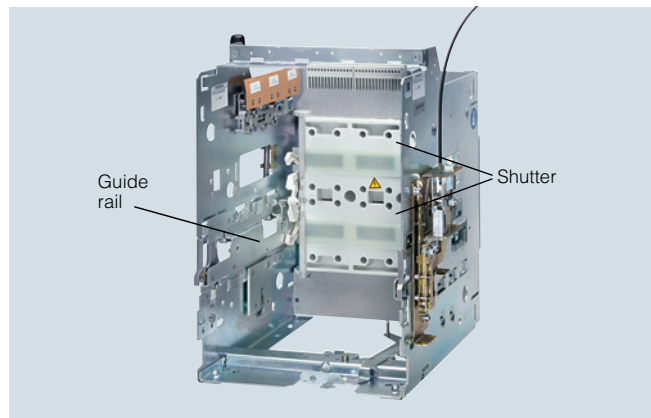

Guide frame

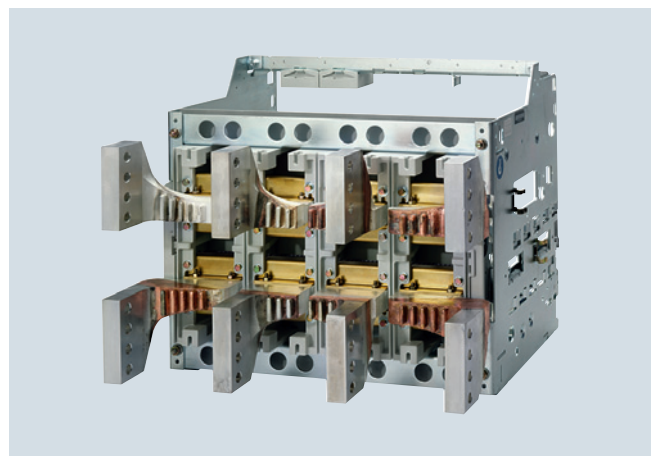

Vertical busbars, up to 3800 A

3WT Air Circuit Breakers up to 4000 A (AC)

General data

Opening, closing and locking devices

- ON and OFF buttons
 - Mechanical ON button
In the standard version, the mechanical ON button is a push-button.
 - Mechanical OFF button
In the standard version, the mechanical OFF button is a pushbutton. As an alternative to a pushbutton, a safety lock (CES) can also be supplied.
If the key is removed in the "0" position, it is no longer possible to close the circuit breaker mechanically.
- Locking device against moving the withdrawable circuit breaker
Access to the crank hole and application of the crank is prevented by means of one or more padlocks. This also prevents movement of the withdrawable circuit breaker in the guide frame.

Auxiliary releases

Up to two auxiliary releases can be installed at the same time. The following are available:

- 1 shunt release or
- 1 undervoltage release or
- 2 shunt releases or
- 1 shunt release +
- 1 undervoltage releases.

Undervoltage releases

The undervoltage release causes the circuit breaker to be opened if the operational voltage falls below a certain value or is not applied. The circuit breaker cannot be closed manually or by means of an electrical ON command if the undervoltage release is not connected to the operational voltage. The undervoltage release has no delay as standard. A delay can be set by the customer in the range between $t_d < 80$ ms and $t_d < 200$ ms.

In addition, an undervoltage release with a delay in the range from 0.2 to 3.2 s is available.

Closing solenoid

The closing solenoid is used to close the circuit breaker electrically by means of a local electrical ON command or by a remote unit.

Motorized operating mechanisms

The operating mechanism is used to load the storage spring automatically.

The operating mechanism is activated if the storage spring has been unloaded and the control voltage is available.

It is switched off automatically after loading. This does not affect manual operation of the storage spring.

Indicators, signals and control elements

Operating cycles counter

The motorized operating mechanism can be supplied with a 5-digit operating cycles counter. The display is incremented by "1" as soon as the storage spring is fully loaded.

Electronic trip units - ETU



Electronic trip units – ETU35WT, ETU37WT, ETU45WT, ETU47WT

The electronic trip unit is controlled by a microprocessor and operates independently of an auxiliary voltage. It enables systems to be adapted to the different protection required of distribution systems, motors, transformers and generators.

In all electronic trip units, the following high-grade features are always included as standard:

- Display with back light
- LSI protection as minimum configuration
- Integrated function test
The test button can be used to test the electronic trip unit using an integrated test function with or without tripping of the circuit breaker (the solid-state trip unit, trip solenoid and breaker mechanism are tested).
- Active LED
Correct operation of the electronic trip unit is indicated by a flashing of a green LED.
When the operating current exceeds the response threshold of the overload protection, it is indicated by rapid flashing of the green LED.
- Cause of tripping
The cause of tripping can be queried locally and displayed (by pressing the "Query" button).
- T. U. Error
A microprocessor fault or overtemperature inside of the electronic trip unit is signaled by a warning indicator LED.

Communication/measuring functions

The use of modern communication-capable circuit breakers opens up completely new possibilities in terms of start-up, parameterization, diagnostics, maintenance and operation. This allows many different ways of reducing costs and improving productivity in industrial plants, buildings and infrastructure projects to be achieved:

- Fast and reliable parameterization
- Timely information and response can prevent plant stoppages
- Effective diagnostics management
- Measured values are the basis for efficient load management, for drawing up power demand profiles and for allocating energy to cost centers
- Preventive maintenance reduces the risk of expensive plant downtimes
- Measurement function with a very wide range of measured values, such as current, voltage, energy, power etc.
- Can be used in 690 V networks

Manual function tester for Electronic trip unit ETU

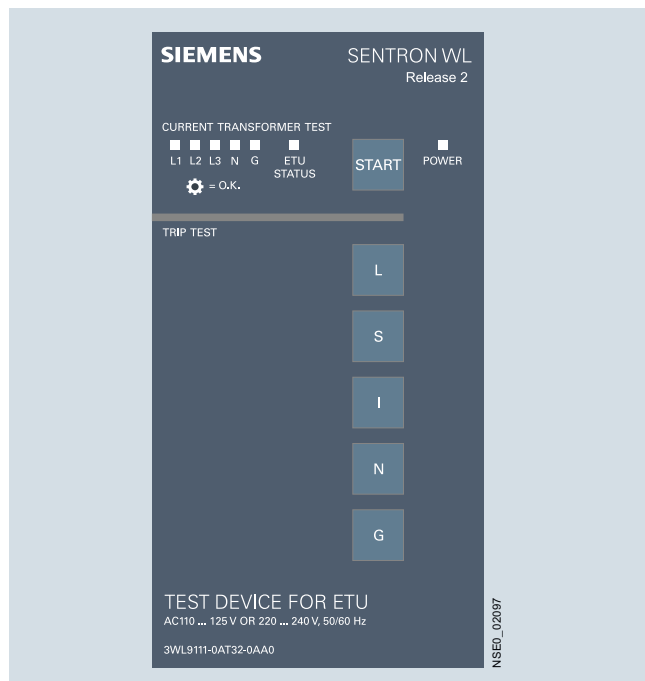

Manual function tester

The manual function tester is used to verify the proper operation of the electronic trip unit, the energy transformers and current transformers as well as the tripping solenoid F5 and the data display.

Ground-fault protection

Description

Ground-fault releases "G" sense fault currents that flow to ground and that can cause fire in the plant. Multiple circuit breakers connected in series can have their delay times adjusted so as to provide time-graded discrimination.

The reason for tripping is indicated by means of an LED when the query button is activated.

Measurement method

Vectorial summation current formation (measurement method 1)

The three phase currents and the N-conductor current are measured directly.

The electronic trip unit determines the ground-fault current by means of vectorial summation current formation for the three phase currents and the N-conductor current.

Direct measurement of the ground-fault current (measurement method 2, only for ETU47WT)

A standard transformer with the following data is used for measurement of the ground-fault current:

1200 A/1 A, Class 1 (the internal load of 3WT is 0.11 Ω). The transformer can be installed directly in the grounded neutral point of a transformer.

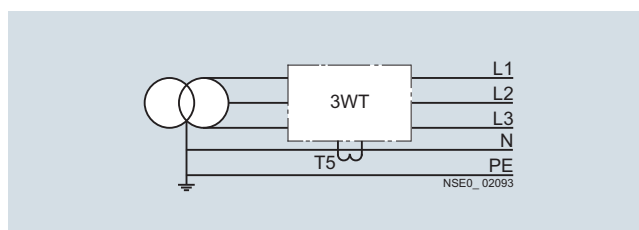

3-pole circuit breakers, current transformers in the neutral conductor

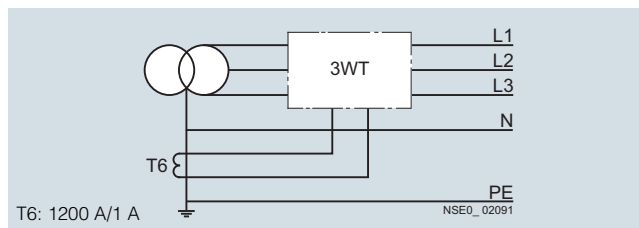

3-pole circuit breakers, current transformers in the grounded neutral point of the transformer

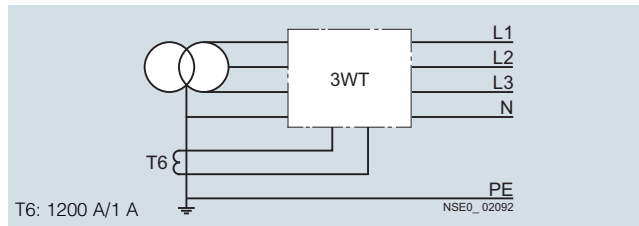

4-pole circuit breakers, current transformers in the grounded neutral point of the transformer

Setting

How the ground fault protection is set depends on the measurements method used (see above):

Measurement method 1: in position ΣI .

Measurement method 2: in position \square_g .

3WT Air Circuit Breakers up to 4000 A (AC)

General data

ETU35WT electronic trip unit

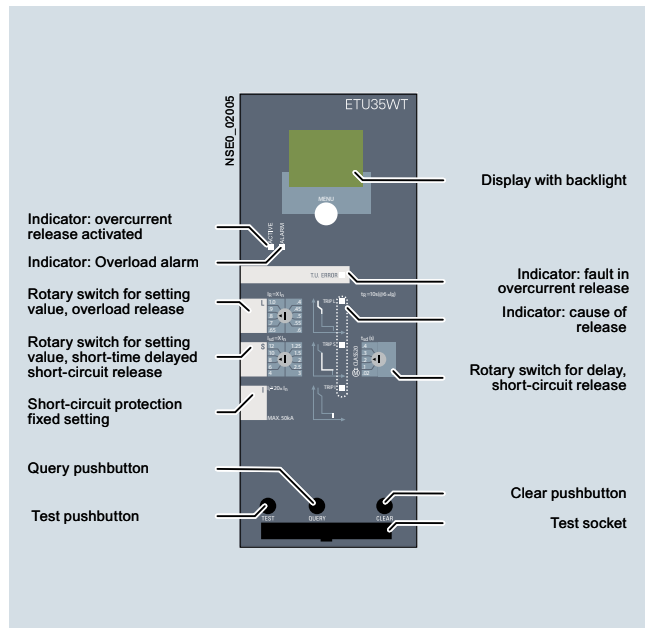

Application:

Classical building, motor and system protection with time-selective coordination for up to 4000 A

Features:

- Adjustable overload protection with I^2t characteristic curve
Delay time
 $t_R = 10$ seconds at $6 \times I_R$
- Short-time delayed short-circuit protection adjustable in the range $1.25 \dots 12 \times I_n$ and
- Instantaneous short-circuit protection preset to $20 \times I_n$, max. 50 kA
- Overload display
- Indicates the reason for tripping by means of an LED
- Test facility for the release
- Protection functions are set by means of the rotary coding switch
- Display with back light

For technical details see the table "Functional Overview of the Electronic Trip Unit System" under "Technical Specifications".

ETU37WT electronic trip unit

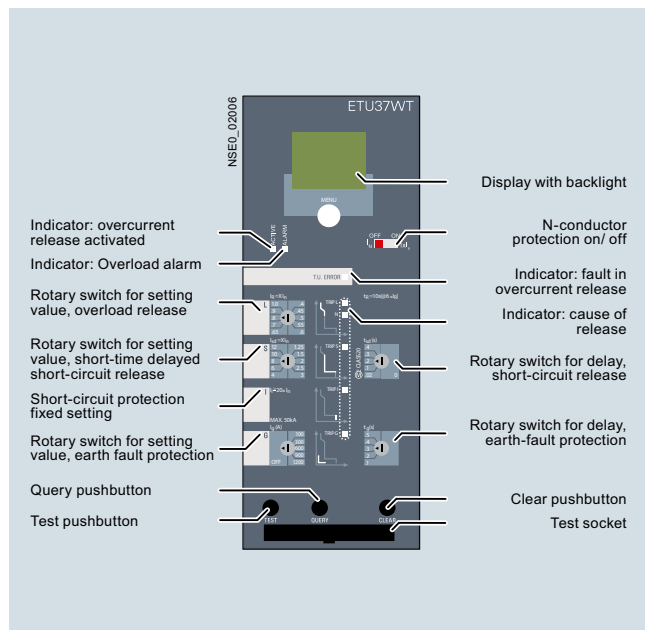

Application:

Classical building, motor and system protection with time-selective coordination for up to 4000 A

Features:

The same as ETU35WT but also

- Reversible neutral conductor protection
- Permanently integrated ground-fault protection. Calculation of the ground-fault current through vectorial summation current formation

For technical details see the table "Functional Overview of the Electronic Trip Unit System" under "Technical Specifications".

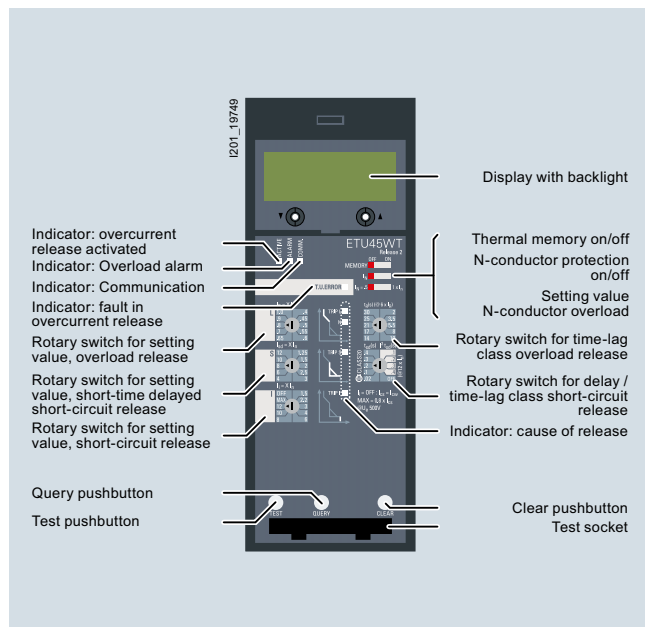
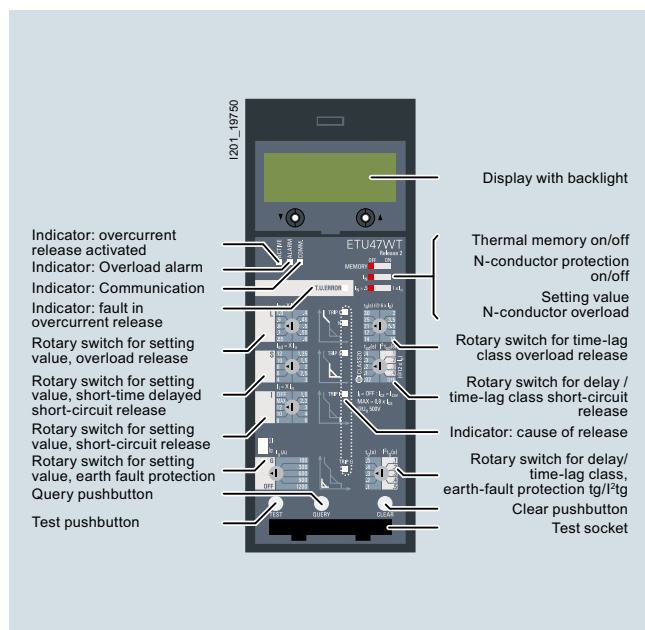
ETU45WT electronic trip unit (Release 2)**ETU47WT electronic trip unit (Release 2)**Application:

Economical all-round system for intelligent buildings and all types of industrial applications

Features:

The same as ETU35WT but also

- Adjustable time-lag class for overload protection
- Selectable characteristic for overload and short-delayed short-circuit range (current discrimination) for more accurate discrimination adaptation to upstream fuses and protective devices
- Thermal image as restart protection for tripped motor outgoing feeders
- Reversible and adjustable (incl. turn off) neutral conductor protection
- The protection functions can be set by means of a rotary coding switch or slide switch
- Communication capability with COM16WT
- Optional metering

For technical details see the table "Functional Overview of the Electronic Trip Unit System" under "Technical Specifications".

Application:

Economical all-round system for intelligent buildings and all types of industrial applications

Features:

The same as ETU45WT but also

- Ground-fault protection with tripping functions which can be adjusted separately

For technical details see the table "Functional Overview of the Electronic Trip Unit System" under "Technical Specifications".

3WT Air Circuit Breakers up to 4000 A (AC)

General data

2

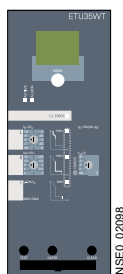
Protection functions
Parameterization by
ETU35WT
D
ETU37WT
D & S
ETU45WT/ETU47WT
D & S
Functional overview of the electronic trip unit system

	L Overload protection Function can be switched on/off Setting range $I_R = I_n \times \dots$	✓	✓	✓
		--	--	--
	Setting range for time-lag class t_R at I^2t	0.4-0.45-0.5-0.55-0.6-0.65-0.7-0.8-0.9-1	0.4-0.45-0.5-0.55-0.6-0.65-0.7-0.8-0.9-1	0.4-0.45-0.5-0.55-0.6-0.65-0.7-0.8-0.9-1
	Setting range for delay time t_R at I^2t	10 s fixed	10 s fixed	2-3-5-5.5-8-10-14-17-21-25-30 s
	Thermal image can be switched on/off	--	--	✓
	Phase failure sensitivity	at $t_{sd} = 20$ ms (M)	at $t_{sd} = 20$ ms (M)	at $t_{sd} = 20$ ms (M)
	N Neutral conductor protection Function can be switched on/off N conductor setting range $I_N = I_n \times \dots$	--	✓	✓
		--	✓	✓
	S Short-time delayed short-circuit protection Function can be switched on/off Setting range $I_{sd} = I_n \times \dots$	✓	✓	✓
		--	--	✓
Setting range for delay time t_{sd}		1.25-1.5-2-2.5-3-4-6-8-10-12	1.25-1.5-2-2.5-3-4-6-8-10-12	1.25-1.5-2-2.5-3-4-6-8-10-12
Setting range for delay time t_{sd}		0-M-100-200-300-400 ms	0-M-100-200-300-400 ms	M-100-200-300-400 ms
Switchable short-time delayed short-circuit protection (I^2t -dependent function)		--	--	✓
I Instantaneous short-circuit protection Function can be switched on/off Setting range $I_i = I_n \times \dots$	--	✓	✓	
	✓	✓	✓	
	Setting range $I_i = I_n \times \dots$	fixed for $I_i \geq 20 \times I_n$, max. 50 kA	fixed for $I_i \geq 20 \times I_n$, max. 50 kA	1.5-2-2-3-4-6-8-10-12-0.8 $\times I_{cs}$
G Ground-fault protection Tripping function can be switched on/off Detection of the ground-fault current through summation current formation with internal or external neutral conductor transformer Detection of ground-fault current through external transformer Setting range of the operating current I_g for release Setting range of the delay time t_g Switchable ground-fault protection characteristic curve (I^2t -dependent function) Setting range for delay time t_g at I^2t	--	✓	✓ (only ETU47WT)	
	--	✓	✓ (only ETU47WT)	
	--	3	✓ (only ETU47WT)	
	--	--	3 (only ETU47WT)	
	Setting range of the operating current I_g for release	--	OFF-100-300-600-900-1200	OFF-100-300-600-900-1200 (only ETU47WT)
	Setting range of the delay time t_g	--	100-200-300-400-500 ms	100-200-300-400-500 ms (only ETU47WT)
Setting range of the delay time t_g at I^2t	--	--	✓ (only ETU47WT)	
--	--	--	100-200-300-400-500 ms (only ETU47WT)	
LCD LCD, with backlight	✓	✓	✓	
	✓	✓	✓	
Watchdog Watchdog	✓	✓	✓	
	✓	✓	✓	
Communication Modbus RTU with COM16WT	--	--	✓	
	--	--	✓	
Metering Metering with internal voltage tap	--	--	✓	
	--	--	✓	
LED display 	Electronic trip unit active	✓	✓	
	Alarm	✓	✓	
	ETU fault	✓	✓	
	L-release	✓	✓	
	S-release	✓	✓	
	I-release	✓	✓	
	N-release	--	✓	
	G-release	--	✓	

Delay time figures given in ms.

✓ Available.

M = Motor protection, corresponds to 20 ms.

-- Not available.

D = Rotary coding switch.

D & S = Rotary coding and slide switch.

Module for mutual mechanical interlocking

The module for mutual mechanical interlocking can be used for one or two 3WT circuit breakers and can be adapted easily to the corresponding versions.

The fixed-mounted and withdrawable circuit breaker versions are fully compatible and can therefore be used in a mixed configuration in an installation.

The circuit breakers can be mounted alongside each other or one above the other, whereby the spacing of the circuit breakers is determined solely by the length of the Bowden wire. The Bowden wires are supplied in standard lengths of 2 m (length: 2 m/3 m/4.5 m). Interlock signals are looped through via the Bowden wires. Interlocking is only effective in the connected position in the case of withdrawable circuit breakers.

The mechanical endurance of the Bowden wires is 10000 operating cycles.

The interlocking module is mounted on the right-hand side of the fixed-mounted circuit breaker (see illustration) or the guide frame.

Minimum requirements must be fulfilled in the switchgear for the interlocking to function:

- Bowden wires must be installed as far as possible in a straight line with minimum bending.
- The bending radii of the Bowden wire must be greater than 500 mm.
- The sum of all bending angles along the Bowden wire must not exceed 640°.
- In a vertical arrangement of circuit breakers to be interlocked, the interlocking mechanisms must be in line.
- Circuit breakers to be interlocked must be arranged so that Bowden wires can be optimally installed in compliance with the conditions mentioned in the above points.
- The installed Bowden wire must be fixed (with cable ties or the like) before the interlock is adjusted.

- Select the width of switchgear cubicle to allow enough freedom of movement for adjusting the interlock!
- Openings and cut-outs in system elements must be designed so that Bowden wires are not changed in direction or obstructed when they are passed through.



3WT circuit breaker, 3-pole, with interlocking module and Bowden wire

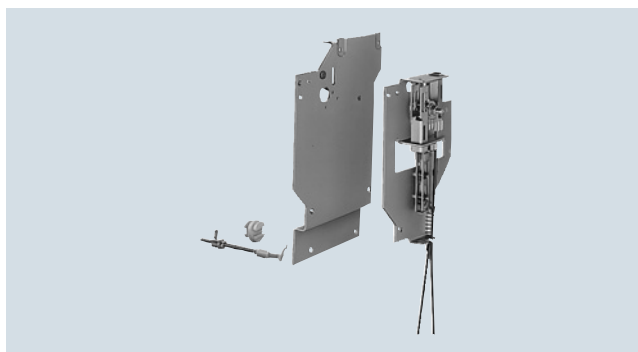

Interlocking module with Bowden wire

Example	Version	Switch status	Description																								
	1	<table border="1"> <thead> <tr> <th>A</th> <th>B</th> </tr> </thead> <tbody> <tr> <td>0</td> <td>0</td> </tr> <tr> <td>1</td> <td>0</td> </tr> <tr> <td>0</td> <td>1</td> </tr> </tbody> </table>	A	B	0	0	1	0	0	1	<p>2 circuit breakers alongside each other: One circuit breaker can only be closed when the other has been switched off. Each circuit breaker has an interlocking module and a Bowden wire.</p>																
A	B																										
0	0																										
1	0																										
0	1																										
	2	<table border="1"> <thead> <tr> <th>A</th> <th>B</th> <th>C</th> </tr> </thead> <tbody> <tr> <td>0</td> <td>0</td> <td>0</td> </tr> <tr> <td>1</td> <td>0</td> <td>0</td> </tr> <tr> <td>0</td> <td>1</td> <td>0</td> </tr> <tr> <td>0</td> <td>0</td> <td>1</td> </tr> <tr> <td>1</td> <td>1</td> <td>0</td> </tr> <tr> <td>0</td> <td>1</td> <td>1</td> </tr> <tr> <td>1</td> <td>0</td> <td>1</td> </tr> </tbody> </table>	A	B	C	0	0	0	1	0	0	0	1	0	0	0	1	1	1	0	0	1	1	1	0	1	<p>3 circuit breakers one above the other: Any two circuit breakers can always be closed, with the third one being interlocked. Each circuit breaker has an interlocking module and a Bowden wire. An additional Bowden wire must be ordered separately for each circuit breaker.</p>
A	B	C																									
0	0	0																									
1	0	0																									
0	1	0																									
0	0	1																									
1	1	0																									
0	1	1																									
1	0	1																									
	3	<table border="1"> <thead> <tr> <th>A</th> <th>B</th> <th>C</th> </tr> </thead> <tbody> <tr> <td>0</td> <td>0</td> <td>0</td> </tr> <tr> <td>1</td> <td>0</td> <td>0</td> </tr> <tr> <td>0</td> <td>1</td> <td>0</td> </tr> <tr> <td>0</td> <td>0</td> <td>1</td> </tr> </tbody> </table>	A	B	C	0	0	0	1	0	0	0	1	0	0	0	1	<p>3 circuit breakers one above the other: When one circuit breaker is closed the other two circuit breakers cannot be closed. The interlocking mechanism of each circuit breaker consists of an interlocking module and a Bowden wire. An additional Bowden wire must be ordered separately for each circuit breaker.</p>									
A	B	C																									
0	0	0																									
1	0	0																									
0	1	0																									
0	0	1																									
	4	<table border="1"> <thead> <tr> <th>A1</th> <th>B</th> <th>A2</th> </tr> </thead> <tbody> <tr> <td>0</td> <td>0</td> <td>0</td> </tr> <tr> <td>1</td> <td>0</td> <td>0</td> </tr> <tr> <td>0</td> <td>0</td> <td>1</td> </tr> <tr> <td>1</td> <td>0</td> <td>1</td> </tr> <tr> <td>0</td> <td>1</td> <td>0</td> </tr> </tbody> </table>	A1	B	A2	0	0	0	1	0	0	0	0	1	1	0	1	0	1	0	<p>3 circuit breakers alongside each other: Two circuit breakers can be closed and opened independently of each other, while the third is only ready to close when the two others are open. If the third circuit breaker is closed, the other two circuit breakers cannot be closed. All three circuit breakers each have an interlocking module and a Bowden wire. A Bowden wire must be ordered separately.</p>						
A1	B	A2																									
0	0	0																									
1	0	0																									
0	0	1																									
1	0	1																									
0	1	0																									

3WT Air Circuit Breakers up to 4000 A (AC)

General data

Technical specifications

Size		I							
		3WT804	3WT806	3WT808	3WT810	3WT812	3WT816		
Type	Main conductor	A	400	630	800	1000	1250	1600	
	Neutral conductor (only on 4-pole version)	A	400	630	800	1000	1250	1600	
Rated operating voltage U_e at 50/60 Hz		AC V	up to 690						
Rated impulse withstand voltage U_{imp}	Main circuits ¹⁾	kV	12						
	Auxiliary circuits	kV	4						
Utilization category			B						
Rated short-circuit making capacity I_{cm} (peak value)	Breaking capacity	up to							
	N	500 V AC	kA	121					
	S	500 V AC	kA	145					
		690 V AC	kA	105					
Rated service short-circuit breaking capacity I_{cs} (rms value)	Breaking capacity	up to							
	N	500 V AC	kA	55					
	S	500 V AC	kA	66					
	Z-Opt. A04	690 V AC	kA	50					
Rated ultimate short-circuit breaking capacity I_{cu} (rms value)	Breaking capacity	up to							
	N	500 V AC	kA	55					
	S	500 V AC	kA	66					
	Z-Opt. A04	690 V AC	kA	50					
Permissible ambient temperatures	Operation	°C	-20 ... +70						
	Storage	°C	-40 ... +80						
Rated short-time withstand current I_{cw} at 50/60 Hz. At a rated voltage of 690 V, the I_{cw} value of the circuit breaker cannot be greater than the I_{cu} or I_{cs} value at 690 V.	0.5 s	kA	50						
	1 s	kA	35 ²⁾ /50						
	2 s	kA	25 ²⁾ /30						
	3 s	kA	20 ²⁾ /25						
	4 s	kA	17 ²⁾ /20						
Permissible load for fixed-mounted and withdrawable circuit breakers at cabinet interior temperature ³⁾⁴⁾	up to 50 °C	A	400	630	800	1000	1250	1600	
	at 60 °C	A	400	630	800	950	1120	1500	
	at 70 °C	A	400	600	700	800	1000	1350	
Rated rotor operating voltage U_{er}		V	2000						
Power loss at I_n with 3-phase symmetr. load (without line-side busbars and metal components ⁴⁾)	Fixed-mounted circuit breaker	W	25	40	60	90	120	140	
	Withdrawable circuit breaker including guide frame	W	50	80	130	205	255	310	
Endurance without maintenance	mechanical	Operating cycles	10000						
	electrical up to 690 V AC ⁶⁾		6000						
with maintenance ⁵⁾	mechanical	Operating cycles	18000						
	electrical up to 690 V AC ⁶⁾		12000						
Operating frequency	mechanical	1/h	60						
	electrical	1/h	60						
Minimum interval between tripping operation by electronic trip unit and next making operation of the circuit breaker (only with automatic mechanical resetting of the lock-out device)		ms	80						
Service position									
Degree of protection			Circuit breaker IP20, when fitted in cabinet or frame Operator panel with door sealing frame IP41						
Main conductor minimum cross-sections	Copper bars, bare	Qty. mm ²	1 × 50 × 10	1 × 50 × 10	1 × 60 × 10	2 × 40 × 10	2 × 60 × 10	2 × 60 × 10	
	Copper bars, painted black	Qty. mm ²	1 × 40 × 10	1 × 40 × 10	1 × 50 × 10	1 × 60 × 10	2 × 40 × 10	2 × 50 × 10	
Auxiliary conductors (Cu) Max. no. of aux. conductors × cross-section		solid and finely stranded with end sleeves	1 × 0.5 ... 2.5 mm ² ; 1 × AWG 14 2 × 1.0 mm ²						
Weights									
3-pole circuit breakers									
• Fixed-mounted circuit breaker	approx. kg		34	34	34	34	34	36	
• Withdrawable circuit breaker	approx. kg		36	36	36	36	36	38	
• Guide frame	approx. kg		22	22	22	22	22	23	
4-pole circuit breakers									
• Fixed-mounted circuit breaker	approx. kg		47	47	47	47	47	49	
• Withdrawable circuit breaker	approx. kg		49	49	49	49	49	51	
• Guide frame	approx. kg		27	27	27	27	27	28	

¹⁾ Rated insulation voltage $U_i = 1000$ V AC.

²⁾ Breaking capacity N.

³⁾ The temperatures apply to the air surrounding the upper third of the circuit breaker.

⁴⁾ These values apply in the case of sinusoidal current (50/60 Hz). The heating/losses increase in the event of harmonics and higher frequencies.

⁵⁾ Maintenance: replacement of the contact set and arc chute.

⁶⁾ Per contact set. Disconnect. of the rated current I_n and power factor = 0.8.

3WT Air Circuit Breakers up to 4000 A (AC)

General data

Size	II						
Type	3WT806	3WT808	3WT810	3WT812	3WT816		
Rated current I_n at 50 °C, at 50/60 Hz ¹⁾	Main conductor	A	630	800	1000	1250	1600
	Neutral conductor (only on 4-pole version)	A	630	800	1000	1250	1600
Rated operating voltage U_e at 50/60 Hz	AC V		up to 690				
Rated impulse withstand voltage U_{imp}	Main circuits ²⁾	kV	12				
	Auxiliary circuits	kV	4				
Utilization category	B						
Rated short-circuit making capacity I_{cm} (peak value)	Breaking capacity up to						
	N	500 V AC	kA	--			
	S	500 V AC	kA	145			
		690 V AC	kA	105			
Rated service short-circuit breaking capacity I_{cs} (rms value)	Breaking capacity up to						
	N	500 V AC	kA	--			
	S	500 V AC	kA	66			
	Z-Opt. A04 / A08	690 V AC	kA	50/66			
Rated ultimate short-circuit breaking capacity I_{cu} (rms value)	Breaking capacity						
	N	500 V AC	kA	--			
	S	500 V AC	kA	66			
	Z-Opt. A04 / A08	690 V AC	kA	50/66			
Permissible ambient temperatures	Operation	°C	-20 ... +70				
	Storage	°C	-40 ... +80				
Rated short-time withstand current I_{cw} at 50/60 Hz At a rated voltage of 690 V, the I_{cw} value of the circuit breaker cannot be greater than the I_{cu} or I_{cs} value at 690 V.	0.5 s		66				
	1 s	kA	66				
	2 s	kA	55				
	3 s	kA	45				
	4 s	kA	35				
Permissible load for fixed-mounted and withdrawable circuit breakers at cabinet interior temperature ³⁾⁴⁾	up to 50 °C ¹⁾	A	630	800	1000	1250	1600
	at 60 °C	A	630	800	1000	1250	1600
	at 70 °C	A	630	800	1000	1250	1600
Rated rotor operating voltage U_{er}	V		2000				
Power loss at I_n with 3-phase symmetr. load (without line-side busbars and metal components ⁴⁾)	Fixed-mounted circuit breaker	W	20	30	45	70	110
	Withdrawable circuit breaker including guide frame	W	40	60	90	140	225
Endurance without maintenance	mechanical	Oper. cycles	10000				
	electrical up to 690 V AC ⁶⁾		6000				
with maintenance ⁵⁾	mechanical	Oper. cycles	12000				
	electrical up to 690 V AC ⁶⁾		12000				
Operating frequency	mechanical	1/h	60				
	electrical up to 690 V AC ⁶⁾	1/h	20				
Minimum interval between tripping operation by electronic trip unit and next making operation of the circuit breaker (only with automatic mechanical resetting of the lockout device)	ms		80				
Service position							
Degree of protection	Circuit breaker IP20, when fitted in cabinet or frame Operator panel with door sealing frame IP41						
Main conductor minimum cross-sections	Copper bars, bare	Qty, mm ²	1 x 50 x 10	1 x 60 x 10	2 x 40 x 10	2 x 60 x 10	2 x 60 x 10
	Copper bars, painted black	Qty, mm ²	1 x 40 x 10	1 x 50 x 10	1 x 60 x 10	2 x 40 x 10	2 x 50 x 10
Auxiliary conductors (Cu)	solid and finely stranded with end sleeves	1 x 0.5 ... 2.5 mm ² ; 1 x AWG 14 2 x 1.0 mm ²					
Weights	3-pole circuit breakers						
	• Fixed-mounted circuit breaker	approx. kg	57				
	• Withdrawable circuit breaker	approx. kg	59				
	• Guide frame	approx. kg	35				
	4-pole circuit breakers						
	• Fixed-mounted circuit breaker	approx. kg	70				
• Withdrawable circuit breaker	approx. kg	72					
• Guide frame	approx. kg	46					

1) At 3WT840: 40 °C.

2) Rated insulation voltage $U_i = 1000$ V AC.

3) The temperatures apply to the air surrounding the upper third of the circuit breaker.

4) These values apply in the case of sinusoidal current (50/60 Hz). The heating/losses increase in the event of harmonics and higher frequencies.

5) Maintenance: replacement of the contact set and arc chute.

6) Per contact set. Disconnect. of the rated current I_n and power factor = 0.8.

3WT Air Circuit Breakers up to 4000 A (AC)

General data

Size		II					
Type			3WT820	3WT825	3WT832	3WT840	
Rated current I_n at 50 °C, at 50/60 Hz ¹⁾	Main conductor	A	2000	2500	3200	3800 (withdrawable)	4000 (fixed-mounted)
	Neutral conductor (only on 4-pole version)	A	2000	2500	3200	3800 (withdrawable)	4000 (fixed-mounted)
Rated operating voltage U_e at 50/60 Hz		AC V	up to 690				
Rated impulse withstand voltage U_{imp}	Main circuits ²⁾	kV	12				
	Auxiliary circuits	kV	4				
Utilization category			B				
Rated short-circuit making capacity I_{cm} (peak value)	Breaking capacity up to						
	N 500 V AC	kA	--				
	S 500 V AC	kA	145				
	Z-Opt. A04 / A08 690 V AC	kA	105/145				
Rated service short-circuit breaking capacity I_{cs} (rms value)	Breaking capacity up to						
	N 500 V AC	kA	--				
	S 500 V AC	kA	66				
	Z-Opt. A04 / A08 690 V AC	kA	50/66	50/66	50	--	
Rated ultimate short-circuit breaking capacity I_{cu} (rms value)	Breaking capacity						
	N 500 V AC	kA	--				
	S 500 V AC	kA	66				
	Z-Opt. A04 / A08 690 V AC	kA	50/66	50/66	50	--	
Permissible ambient temperatures	Operation	°C	-20 ... +70				
	Storage	°C	-40 ... +80				
Rated short-time withstand current I_{cw} at 50/60 Hz At a rated voltage of 690 V, the I_{cw} value of the circuit breaker cannot be greater than the I_{cu} or I_{cs} value at 690 V.	0.5 s		66				
	1 s	kA	66				
	2 s	kA	55				
	3 s	kA	45				
	4 s	kA	35				
Permissible load for fixed-mounted and withdrawable circuit breakers at cabinet interior temperature ³⁾⁴⁾	up to 50 °C ¹⁾	A	2000	2500	3200	3800 ⁵⁾	4000 ⁶⁾
	at 60 °C	A	1950	2150	2900		
	at 70 °C	A	1800	1950	2700		
Rated rotor operating voltage U_{er}		V	2000				
Power loss at I_n with 3-phase symmetr. load (without line-side busbars and metal components ⁴⁾)	Fixed-mounted circuit breaker	W	170	325	420	--	902
	Withdrawable circuit breaker including guide frame	W	310	535	760	1050	--
Endurance without maintenance	mechanical	Oper. cycles	10000		4000		2000 ¹⁰⁾
	electrical up to 690 V AC ⁸⁾		6000		2000 ¹⁰⁾		2000 ¹⁰⁾
with maintenance ⁷⁾	mechanical	Oper. cycles	12000		10000		4000 ¹⁰⁾
	electrical up to 690 V AC ⁸⁾		12000		4000 ¹⁰⁾		4000 ¹⁰⁾
Operating frequency	mechanical	1/h	60		60		60
	electrical up to 690 V AC ⁸⁾	1/h	20	20	10	60	60
Minimum interval between tripping operation by electronic trip unit and next making operation of the circuit breaker (only with automatic mechanical resetting of the lockout device)		ms	80				
Service position							
Degree of protection	Circuit breaker IP20, when fitted in cabinet or frame Operator panel with door sealing frame IP41						
Main conductor minimum cross-sections	Copper bars, bare	Qty, mm ²	2 × 100 × 10	3 × 100 × 10	3 × 100 × 10	4 × 120 × 10	4 × 120 × 10
	Copper bars, painted black	Qty, mm ²	2 × 80 × 10	2 × 100 × 10	3 × 100 × 10	4 × 100 × 10	4 × 100 × 10
Auxiliary conductors (Cu)	solid and finely stranded with end sleeves		1 × 0.5 ... 2.5 mm ² ; 1 × AWG 14				
Max. no. of aux. conductors × cross-section			2 × 1.0 mm ²				
Weights							
3-pole circuit breakers							
• Fixed-mounted circuit breaker	approx. kg		57	57	61	--	92 ⁹⁾
• Withdrawable circuit breaker	approx. kg		59	59	63	64	--
• Guide frame	approx. kg		35	35	37	54 ⁹⁾	--
4-pole circuit breakers							
• Fixed-mounted circuit breaker	approx. kg		70	70	74	--	106 ⁹⁾
• Withdrawable circuit breaker	approx. kg		72	72	76	77	--
• Guide frame	approx. kg		46	46	48	64 ⁹⁾	--

1) At 3WT840: 40 °C.

2) Rated insulation voltage U_i = 1000 V AC.

3) The temperatures apply to the air surrounding the upper third of the circuit breaker.

4) These values apply in the case of sinusoidal current (50/60 Hz). The heating/losses increase in the event of harmonics and higher frequencies.

5) Withdrawable circuit breakers.

6) Fixed-mounted circuit breakers.

7) Maintenance: replacement of the contact set and arc chute.

8) Per contact set. Disconnect. of the rated current I_n and power factor = 0.8.

9) Including vertical busbars.

10) At 3WT840 applicable up to 500V AC only.

				3WT
Operating mechanisms				
Manual operating mechanism with mechanical closing				
Closing	Max. force required to operate the hand lever		N	210
Charging stored-energy feature	Required number of strokes on the hand lever			5
Manual operating mechanism with mechanical and electrical closing				
Charging stored-energy feature				see "Manual operating mechanism with mechanical closing"
Closing solenoid (Y1)	Operating range			$0.7 \dots 1.1 \times U_s$
	Extended operating range for battery operation ¹⁾	for 24 V DC, 110 V DC, 220 V DC		$0.7 \dots 1.26 \times U_s$
	Power input	AC/DC	VAW	15
	Minimum command duration at U_s for the activation solenoid			ms 60
	Total closing time at U_s after start of closing command for the activation solenoid, suitable for synchronizing tasks			ms 80
	Short-circuit protection			
	Smallest permissible DIAZED fuse (operational class gL)/miniature circuit breaker with C-characteristic			1 A TDz (time-lag)/1 A
Manual/motor operating mechanism with mechanical and electrical closing				
Manual operating mechanism				see "Manual operating mechanism with mechanical closing"
Motor	Operating range			$0.7 \dots 1.1 \times U_s$
	Extended operating range for battery operation ¹⁾	for 24 V DC, 110 V DC, 220 V DC		$0.7 \dots 1.26 \times U_s$
	Power input to motor	AC/DC	VAW	40
	Time required to charge the stored-energy mechanism $1 \times U_s$		s	20
Closing solenoid				see "Manual operating mechanism with mechanical and electrical closing"
	Short-circuit protection			
	Motor and activation solenoid for the <u>same</u> rated control supply voltages:			
For motor and closing solenoid	Smallest permissible DIAZED fuse (operational class gL)/miniature circuit breaker with C-characteristic	at $U_s = 24$ V		2 A TDz (time-lag)/2 A
		at $U_s = 110 \dots 127$ V		1 A TDz (time-lag)/1 A
		at $U_s = 220 \dots 250$ V		1 A TDz (time-lag)/1 A
Auxiliary releases				
Shunt release "f" (F1, F2)	Operating value	pickup		$\geq 0.7 \times U_s$ (circuit breaker is tripped)
	Operating range			$0.7 \dots 1.1 \times U_s$
	For continuous command (100 % duty ratio), locks out on momentary-contact commands			
	Extended operating range for battery operation ¹⁾	for 24 V DC, 110 V DC, 220 V DC		$0.7 \dots 1.26 \times U_s$
	Rated control supply voltage U_s	AC 50/60 Hz	V	110 ... 127, 220 ... 240
		DC	V	24, 110 ... 125, 220 ... 250
	Power input	AC/DC	VAW	15
	Minimum command duration at U_s			ms 60
	Opening time of circuit breaker at $U_s = 100$ %	AC/DC		ms ≤ 80

¹⁾ The operating range is only permissible for the specified rated voltages and corresponds to the battery charging voltage.

3WT Air Circuit Breakers up to 4000 A (AC)

General data

Auxiliary releases		3WT					
Undervoltage release "r" (F3) and "rc" (F8)	Operating values	pickup	$\geq 0.85 \times U_s$ (circuit breaker can be closed)				
		dropout	$(0.35 \dots 0.7) \times U_s$ (circuit breaker is tripped)				
	Operating range		$0.85 \dots 1.1 \times U_s$				
	Extended operating range in battery operation ¹⁾	for 24 V DC, 110 V DC, 220 V DC	$0.7 \dots 1.26 \times U_s$				
	Rated control supply voltage U_s	AC 50/60 Hz	V	110 ... 127, 220 ... 240, 380 ... 415			
		DC	V	24, 110 ... 125, 220 ... 250			
	Power input	AC	VA	15			
		DC	W	15			
	Opening time of circuit breaker at $U_s = 0$						
	Version "r" (F3)						
Instantaneous		ms	≤ 100				
With 100 ms delay		ms	≤ 300				
Version "rc" (F8)							
With delay, $t_d = 0.2 \dots 3.2$ s		s	0.2 ... 3.2				
Reset via additional NC contact – direct switching-off		ms	≤ 100				
Short-circuit protection							
Smallest permissible DIAZED fuse (operational class gL)/ miniature circuit breaker with C-characteristic			1 A TDz (time-lag) 1 A				
Contact position-driven auxiliary switches (S1, S2, S3, S4, S5, S6, S60, S61)							
Rated insulation voltage U_i		AC/DC V	400				
Rated operating voltage U_e		V	400				
Switching capacity AC, 50/60 Hz	Rated operating voltage U_e	V	up to 24	110	220/230	380/400	
		A	10	10	10	10	
		A	6	6	6	4	
	DC	Rated operating voltage U_e	V	24	110	220	
			A	10	3.5	1	
			A	10	1.2	0.4	
Short-circuit protection²⁾			10 A TDz, 16 A Dz				
Largest permissible miniature circuit breaker with C-characteristic			10 A				
Ready-to-close signaling switch (S7) and "tripped" signaling switch (S11)							
Switching capacity AC, 50/60 Hz	Rated operating voltage U_e	V	110	220			
		A	0.14	0.1			
	DC	Rated operating voltage U_e	V	24	220		
			A	0.2	0.1		
Short-circuit protection²⁾			2 A Dz (quick)				
"Tripped" signaling switch (S11)		Signal duration after tripping	continuous, until reset				

¹⁾ The operating range is only permissible for the specified rated voltages and corresponds to the battery charging voltage.

²⁾ Without any welding of the contacts only at $I_k \leq 1$ kA in accordance with IEC 60947-5-1.

Selection and ordering data – quick selection

Size	Rated current I_n	Short-circuit breaking capacity $I_{cu}/500\text{ V}$	Short-time withstand current, $I_{cw}/500\text{ V}$ (1 s ¹⁾)	3-pole		4-pole	
				Article No.	Weight approx. kg	Article No.	Weight approx. kg
ETU35WT, horizontal main circuit connection (breaking capacity N)							
I	400	55	50	3WT8040-5UA34-5AB2	58.000	3WT8044-5UA34-5AB2	76.000
I	630	55	50	3WT8060-5UA34-5AB2	58.000	3WT8064-5UA34-5AB2	76.000
I	800	55	50	3WT8080-5UA34-5AB2	58.000	3WT8084-5UA34-5AB2	76.000
I	1000	55	50	3WT8100-5UA34-5AB2	58.000	3WT8104-5UA34-5AB2	76.000
I	1250	55	50	3WT8120-5UA34-5AB2	58.000	3WT8124-5UA34-5AB2	76.000
I	1600	55	50	3WT8160-5UA34-5AB2	61.000	3WT8164-5UA34-5AB2	79.000
ETU35WT, horizontal main circuit connection (breaking capacity S)							
I	400	66	50	3WT8041-5UA34-5AB2	58.000	3WT8045-5UA34-5AB2	76.000
I	630	66	50	3WT8061-5UA34-5AB2	58.000	3WT8065-5UA34-5AB2	76.000
I	800	66	50	3WT8081-5UA34-5AB2	58.000	3WT8085-5UA34-5AB2	76.000
I	1000	66	50	3WT8101-5UA34-5AB2	58.000	3WT8105-5UA34-5AB2	76.000
I	1250	66	50	3WT8121-5UA34-5AB2	58.000	3WT8125-5UA34-5AB2	76.000
I	1600	66	50	3WT8161-5UA34-5AB2	61.000	3WT8165-5UA34-5AB2	79.000
II	630	66	66	3WT8062-5UA34-5AB2	94.000	3WT8066-5UA34-5AB2	118.000
II	800	66	66	3WT8082-5UA34-5AB2	94.000	3WT8086-5UA34-5AB2	118.000
II	1000	66	66	3WT8102-5UA34-5AB2	94.000	3WT8106-5UA34-5AB2	118.000
II	1250	66	66	3WT8122-5UA34-5AB2	94.000	3WT8126-5UA34-5AB2	118.000
II	1600	66	66	3WT8162-5UA34-5AB2	94.000	3WT8166-5UA34-5AB2	118.000
II	2000	66	66	3WT8202-5UA34-5AB2	94.000	3WT8206-5UA34-5AB2	118.000
II	2500	66	66	3WT8252-5UA34-5AB2	94.000	3WT8256-5UA34-5AB2	118.000
II	3200	66	66	3WT8322-5UA34-5AB2	100.000	3WT8326-5UA34-5AB2	124.000
ETU35WT, vertical main circuit connection (breaking capacity S)							
II	3800	66	66	3WT8402-5UA36-5AB2	100.000	3WT8406-5UA36-5AB2	141.000
ETU37WT, horizontal main circuit connection (breaking capacity N)							
I	400	55	50	3WT8040-6UA34-5AB2	58.000	3WT8044-6UA34-5AB2	76.000
I	630	55	50	3WT8060-6UA34-5AB2	58.000	3WT8064-6UA34-5AB2	76.000
I	800	55	50	3WT8080-6UA34-5AB2	58.000	3WT8084-6UA34-5AB2	76.000
I	1000	55	50	3WT8100-6UA34-5AB2	58.000	3WT8104-6UA34-5AB2	76.000
I	1250	55	50	3WT8120-6UA34-5AB2	58.000	3WT8124-6UA34-5AB2	76.000
I	1600	55	50	3WT8160-6UA34-5AB2	61.000	3WT8164-6UA34-5AB2	79.000
ETU37WT, horizontal main circuit connection (breaking capacity S)							
I	400	66	50	3WT8041-6UA34-5AB2	58.000	3WT8045-6UA34-5AB2	76.000
I	630	66	50	3WT8061-6UA34-5AB2	58.000	3WT8065-6UA34-5AB2	76.000
I	800	66	50	3WT8081-6UA34-5AB2	58.000	3WT8085-6UA34-5AB2	76.000
I	1000	66	50	3WT8101-6UA34-5AB2	58.000	3WT8105-6UA34-5AB2	76.000
I	1250	66	50	3WT8121-6UA34-5AB2	58.000	3WT8125-6UA34-5AB2	76.000
I	1600	66	50	3WT8161-6UA34-5AB2	61.000	3WT8165-6UA34-5AB2	79.000
II	630	66	66	3WT8062-6UA34-5AB2	94.000	3WT8066-6UA34-5AB2	118.000
II	800	66	66	3WT8082-6UA34-5AB2	94.000	3WT8086-6UA34-5AB2	118.000
II	1000	66	66	3WT8102-6UA34-5AB2	94.000	3WT8106-6UA34-5AB2	118.000
II	1250	66	66	3WT8122-6UA34-5AB2	94.000	3WT8126-6UA34-5AB2	118.000
II	1600	66	66	3WT8162-6UA34-5AB2	94.000	3WT8166-6UA34-5AB2	118.000
II	2000	66	66	3WT8202-6UA34-5AB2	94.000	3WT8206-6UA34-5AB2	118.000
II	2500	66	66	3WT8252-6UA34-5AB2	94.000	3WT8256-6UA34-5AB2	118.000
II	3200	66	66	3WT8322-6UA34-5AB2	100.000	3WT8326-6UA34-5AB2	124.000
ETU37WT, vertical main circuit connection (breaking capacity S)							
II	3800	66	66	3WT8402-6UA36-5AB2	100.000	3WT8406-6UA36-5AB2	141.000

Electronic trip unit (ETU)

ETU35WT: protection functions LSI with LCD display
 ETU37WT: protection functions LSING²⁾ with LCD display

Accessories included

Motor operated mechanism,
 with mechanical and electrical closing,
 motor and closing solenoid 220-240 V AC 50/60 Hz,
 220-250 V DC,

Shunt release *F¹⁾ 220-240 V AC 50/60 Hz,
 220-250 V DC

with door sealing frame IP41, sealing cap over OFF button,
 and shutter
 without 2nd auxiliary release,
 with auxiliary switch 2 NO + 2 NC,
 with shutter

¹⁾ $I_{cw}/500\text{ V}$ 0.5 s for breaking capacity N.

²⁾ Current transformer for overload protection in the neutral conductor and for ground-fault protection must be ordered separately, see page 2/32.

3WT Air Circuit Breakers up to 4000 A (AC)

3- and 4-pole, fixed-mounted version inclusive standard accessories

Selection and ordering data – quick selection

Size	Rated current I_n	Short-circuit breaking capacity $I_{cu}/500\text{ V}$	Short-time withstand current, $I_{cw}/500\text{ V}$ (1 s ¹⁾)	3-pole		4-pole	
				Article No.	Weight approx.	Article No.	Weight approx.
A	kA	kA	kA		kg		kg
ETU35WT, horizontal main circuit connection (breaking capacity N)							
I	400	55	50	3WT8040-5UA30-0AA2	34.000	3WT8044-5UA30-0AA2	47.000
I	630	55	50	3WT8060-5UA30-0AA2	34.000	3WT8064-5UA30-0AA2	47.000
I	800	55	50	3WT8080-5UA30-0AA2	34.000	3WT8084-5UA30-0AA2	47.000
I	1000	55	50	3WT8100-5UA30-0AA2	34.000	3WT8104-5UA30-0AA2	47.000
I	1250	55	50	3WT8120-5UA30-0AA2	34.000	3WT8124-5UA30-0AA2	47.000
I	1600	55	50	3WT8160-5UA30-0AA2	36.000	3WT8164-5UA30-0AA2	49.000
ETU35WT, horizontal main circuit connection (breaking capacity S)							
I	400	66	50	3WT8041-5UA30-0AA2	34.000	3WT8045-5UA30-0AA2	47.000
I	630	66	50	3WT8061-5UA30-0AA2	34.000	3WT8065-5UA30-0AA2	47.000
I	800	66	50	3WT8081-5UA30-0AA2	34.000	3WT8085-5UA30-0AA2	47.000
I	1000	66	50	3WT8101-5UA30-0AA2	34.000	3WT8105-5UA30-0AA2	47.000
I	1250	66	50	3WT8121-5UA30-0AA2	34.000	3WT8125-5UA30-0AA2	47.000
I	1600	66	50	3WT8161-5UA30-0AA2	36.000	3WT8165-5UA30-0AA2	49.000
II	630	66	66	3WT8062-5UA30-0AA2	57.000	3WT8066-5UA30-0AA2	70.000
II	800	66	66	3WT8082-5UA30-0AA2	57.000	3WT8086-5UA30-0AA2	70.000
II	1000	66	66	3WT8102-5UA30-0AA2	57.000	3WT8106-5UA30-0AA2	70.000
II	1250	66	66	3WT8122-5UA30-0AA2	57.000	3WT8126-5UA30-0AA2	70.000
II	1600	66	66	3WT8162-5UA30-0AA2	57.000	3WT8166-5UA30-0AA2	70.000
II	2000	66	66	3WT8202-5UA30-0AA2	57.000	3WT8206-5UA30-0AA2	70.000
II	2500	66	66	3WT8252-5UA30-0AA2	57.000	3WT8256-5UA30-0AA2	70.000
II	3200	66	66	3WT8322-5UA30-0AA2	61.000	3WT8326-5UA30-0AA2	74.000
ETU35WT, vertical main circuit connection (breaking capacity S)							
II	4000	66	66	3WT8402-5UA32-0AA2	92.000	3WT8406-5UA32-0AA2	106.000
ETU37WT, horizontal main circuit connection (breaking capacity N)							
I	400	55	50	3WT8040-6UA30-0AA2	34.000	3WT8044-6UA30-0AA2	47.000
I	630	55	50	3WT8060-6UA30-0AA2	34.000	3WT8064-6UA30-0AA2	47.000
I	800	55	50	3WT8080-6UA30-0AA2	34.000	3WT8084-6UA30-0AA2	47.000
I	1000	55	50	3WT8100-6UA30-0AA2	34.000	3WT8104-6UA30-0AA2	47.000
I	1250	55	50	3WT8120-6UA30-0AA2	34.000	3WT8124-6UA30-0AA2	47.000
I	1600	55	50	3WT8160-6UA30-0AA2	36.000	3WT8164-6UA30-0AA2	49.000
ETU37WT, horizontal main circuit connection (breaking capacity S)							
I	400	66	50	3WT8041-6UA30-0AA2	34.000	3WT8045-6UA30-0AA2	47.000
I	630	66	50	3WT8061-6UA30-0AA2	34.000	3WT8065-6UA30-0AA2	47.000
I	800	66	50	3WT8081-6UA30-0AA2	34.000	3WT8085-6UA30-0AA2	47.000
I	1000	66	50	3WT8101-6UA30-0AA2	34.000	3WT8105-6UA30-0AA2	47.000
I	1250	66	50	3WT8121-6UA30-0AA2	34.000	3WT8125-6UA30-0AA2	47.000
I	1600	66	50	3WT8161-6UA30-0AA2	36.000	3WT8165-6UA30-0AA2	49.000
II	630	66	66	3WT8062-6UA30-0AA2	57.000	3WT8066-6UA30-0AA2	70.000
II	800	66	66	3WT8082-6UA30-0AA2	57.000	3WT8086-6UA30-0AA2	70.000
II	1000	66	66	3WT8102-6UA30-0AA2	57.000	3WT8106-6UA30-0AA2	70.000
II	1250	66	66	3WT8122-6UA30-0AA2	57.000	3WT8126-6UA30-0AA2	70.000
II	1600	66	66	3WT8162-6UA30-0AA2	57.000	3WT8166-6UA30-0AA2	70.000
II	2000	66	66	3WT8202-6UA30-0AA2	57.000	3WT8206-6UA30-0AA2	70.000
II	2500	66	66	3WT8252-6UA30-0AA2	57.000	3WT8256-6UA30-0AA2	70.000
II	3200	66	66	3WT8322-6UA30-0AA2	61.000	3WT8326-6UA30-0AA2	74.000
ETU37WT, vertical main circuit connection (breaking capacity S)							
II	4000	66	66	3WT8402-6UA32-0AA2	92.000	3WT8406-6UA32-0AA2	106.000

Electronic trip unit (ETU)

ETU35WT: protection functions LSI with LCD display

ETU37WT: protection functions LSING²⁾ with LCD display

Accessories included

Motor operated mechanism,
with mechanical and electrical closing,
motor and closing solenoid 220-240 V AC 50/60 Hz,
220-250 V DC,
Shunt release *F 220-240 V AC 50/60 Hz,
220-250 V DC

with door sealing frame IP41,
without 2nd auxiliary release,
with auxiliary switch 2 NO + 2 NC

¹⁾ $I_{cw}/500\text{ V}$ 0.5 s for breaking capacity N.

²⁾ Current transformer for overload protection in the neutral conductor and for ground-fault protection must be ordered separately, see page 2/32.

Selection and ordering data

Size	Rated current I_n	Short-circuit breaking capacity $I_{cu}/500\text{ V}$	Short-time withstand current, $I_{cw}/500\text{ V}$ (1 s ¹⁾)	3-pole		Weight approx. kg	4-pole		Weight approx. kg
				Article No.	Article No. supplement (8th to 11th and 13th to 16th position of Article No.) must be added. For quick selection see below. Further options see pages 2/25 to 2/31.		Article No.	Article No. supplement (8th to 11th and 13th to 16th position of Article No.) must be added. For quick selection see below. Further options see pages 2/25 to 2/31.	
A	kA	kA	kA						
Horizontal main circuit connection (breaking capacity N)									
I	400	55	50	3WT8040-□□□□4-□□□□		58.000	3WT8044-□□□□4-□□□□		76.000
I	630	55	50	3WT8060-□□□□4-□□□□		58.000	3WT8064-□□□□4-□□□□		76.000
I	800	55	50	3WT8080-□□□□4-□□□□		58.000	3WT8084-□□□□4-□□□□		76.000
I	1000	55	50	3WT8100-□□□□4-□□□□		58.000	3WT8104-□□□□4-□□□□		76.000
I	1250	55	50	3WT8120-□□□□4-□□□□		58.000	3WT8124-□□□□4-□□□□		76.000
I	1600	55	50	3WT8160-□□□□4-□□□□		58.000	3WT8164-□□□□4-□□□□		76.000
Horizontal main circuit connection (breaking capacity S)									
I	400	66	50	3WT8041-□□□□4-□□□□		58.000	3WT8045-□□□□4-□□□□		76.000
I	630	66	50	3WT8061-□□□□4-□□□□		58.000	3WT8065-□□□□4-□□□□		76.000
I	800	66	50	3WT8081-□□□□4-□□□□		58.000	3WT8085-□□□□4-□□□□		76.000
I	1000	66	50	3WT8101-□□□□4-□□□□		58.000	3WT8105-□□□□4-□□□□		76.000
I	1250	66	50	3WT8121-□□□□4-□□□□		58.000	3WT8125-□□□□4-□□□□		76.000
I	1600	66	50	3WT8161-□□□□4-□□□□		61.000	3WT8165-□□□□4-□□□□		79.000
II	630	66	66	3WT8062-□□□□4-□□□□		94.000	3WT8066-□□□□4-□□□□		118.000
II	800	66	66	3WT8082-□□□□4-□□□□		94.000	3WT8086-□□□□4-□□□□		118.000
II	1000	66	66	3WT8102-□□□□4-□□□□		94.000	3WT8106-□□□□4-□□□□		118.000
II	1250	66	66	3WT8122-□□□□4-□□□□		94.000	3WT8126-□□□□4-□□□□		118.000
II	1600	66	66	3WT8162-□□□□4-□□□□		94.000	3WT8166-□□□□4-□□□□		118.000
II	2000	66	66	3WT8202-□□□□4-□□□□		94.000	3WT8206-□□□□4-□□□□		118.000
II	2500	66	66	3WT8252-□□□□4-□□□□		94.000	3WT8256-□□□□4-□□□□		118.000
II	3200	66	66	3WT8322-□□□□4-□□□□		100.000	3WT8326-□□□□4-□□□□		124.000
Horizontal main circuit connection at top, vertical connection at bottom (breaking capacity N)⁵⁾									
I	400	55	50	3WT8040-□□□□8-□□□□		58.000	3WT8044-□□□□8-□□□□		76.000
I	630	55	50	3WT8060-□□□□8-□□□□		58.000	3WT8064-□□□□8-□□□□		76.000
I	800	55	50	3WT8080-□□□□8-□□□□		58.000	3WT8084-□□□□8-□□□□		76.000
I	1000	55	50	3WT8100-□□□□8-□□□□		58.000	3WT8104-□□□□8-□□□□		76.000
I	1250	55	50	3WT8120-□□□□8-□□□□		58.000	3WT8124-□□□□8-□□□□		76.000
I	1600	55	50	3WT8160-□□□□8-□□□□		58.000	3WT8164-□□□□8-□□□□		76.000

Electronic trip unit (ETU; 8th position of Article No.)

ETU35WT: LSI with LCD display
 ETU37WT: LSING²⁾ with LCD display
 ETU45WT: LSIN²⁾⁶⁾ with LCD display and additional features
 ETU47WT: LSING²⁾⁶⁾ with LCD display and additional features

Operating mechanism, auxiliary release, auxiliary switch (9th to 11th position of Article No., further options see page 2/25)

Manual operating mechanism, with mechanical closing, without 1st and 2nd auxiliary releases, with auxiliary switch 2 NO + 2 NC

Accessories (13th to 16th position of Article No., further options see pages 2/26 to 2/31)

with door sealing frame IP41,
 with door sealing frame IP41, sealing cap over OFF button, and shutter size I, up to 1600 A size II, 630 ... 3800 A
 with door sealing frame IP41, safety lock device CES instead of OFF button³⁾ (key removable in OFF position); and shutter size I, up to 1600 A size II, 630 ... 3800 A

Article No. supplements	Additional price
5	X
6	X
7	X
8	X
AA0	without
5AA2	without
4) 5AB2	X
	X
4) 5AF2	X
	X

Article No. supplements	Additional price
5	X
6	X
7	X
8	X
AA0	without
5AA2	without
4) 5AB2	X
	X
4) 5AF2	X
	X

1) $I_{cw}/500\text{ V } 0.5\text{ s}$ for breaking capacity N.
 2) Current transformer for overload protection in the neutral conductor and for ground-fault protection must be ordered separately, see page 2/32.
 3) This disables mechanical or electrical ON commands.
 4) Not available for circuit breakers without guide frame, see also page 2/26.
 5) Can be converted to vertical at top and horizontal main connection at bottom.
 6) ETU Release 2 prepared for communication and metering.

X = additional price

3WT Air Circuit Breakers up to 4000 A (AC)

3- and 4-pole, withdrawable version

Size	Rated current I_n	Short-circuit breaking capacity $I_{cu}/500\text{ V}$	Short-time withstand current, $I_{cw}/500\text{ V}$ 1 s ¹⁾	3-pole		4-pole	
				Article No.	Weight approx.	Article No.	Weight approx.
A	kA	kA	kA	Article No. supplement (8th to 11th and 13th to 16th position of Article No.) must be added. For quick selection see below. Further options see pages 2/25 to 2/31.	kg	Article No. supplement (8th to 11th and 13th to 16th position of Article No.) must be added. For quick selection see below. Further options see pages 2/25 to 2/31.	kg

Horizontal main circuit connection at top, vertical connection at bottom⁵⁾ (breaking capacity S)

I	400	66	50	3WT8041-□□□□8-□□□□	58.000	3WT8045-□□□□8-□□□□	76.000
I	630	66	50	3WT8061-□□□□8-□□□□	58.000	3WT8065-□□□□8-□□□□	76.000
I	800	66	50	3WT8081-□□□□8-□□□□	58.000	3WT8085-□□□□8-□□□□	76.000
I	1000	66	50	3WT8101-□□□□8-□□□□	58.000	3WT8105-□□□□8-□□□□	76.000
I	1250	66	50	3WT8121-□□□□8-□□□□	58.000	3WT8125-□□□□8-□□□□	76.000
I	1600	66	50	3WT8161-□□□□8-□□□□	61.000	3WT8165-□□□□8-□□□□	79.000
II	630	66	66	3WT8062-□□□□8-□□□□	94.000	3WT8066-□□□□8-□□□□	118.000
II	800	66	66	3WT8082-□□□□8-□□□□	94.000	3WT8086-□□□□8-□□□□	118.000
II	1000	66	66	3WT8102-□□□□8-□□□□	94.000	3WT8106-□□□□8-□□□□	118.000
II	1250	66	66	3WT8122-□□□□8-□□□□	94.000	3WT8126-□□□□8-□□□□	118.000
II	1600	66	66	3WT8162-□□□□8-□□□□	94.000	3WT8166-□□□□8-□□□□	118.000
II	2000	66	66	3WT8202-□□□□8-□□□□	94.000	3WT8206-□□□□8-□□□□	118.000
II	2500	66	66	3WT8252-□□□□8-□□□□	94.000	3WT8256-□□□□8-□□□□	118.000
II	3200	66	66	3WT8322-□□□□8-□□□□	100.000	3WT8326-□□□□8-□□□□	124.000

Vertical main circuit connection, top and bottom (breaking capacity N)

I	400	55	50	3WT8040-□□□□6-□□□□	58.000	3WT8044-□□□□6-□□□□	76.000
I	630	55	50	3WT8060-□□□□6-□□□□	58.000	3WT8064-□□□□6-□□□□	76.000
I	800	55	50	3WT8080-□□□□6-□□□□	58.000	3WT8084-□□□□6-□□□□	76.000
I	1000	55	50	3WT8100-□□□□6-□□□□	58.000	3WT8104-□□□□6-□□□□	76.000
I	1250	55	50	3WT8120-□□□□6-□□□□	58.000	3WT8124-□□□□6-□□□□	76.000
I	1600	55	50	3WT8160-□□□□6-□□□□	58.000	3WT8164-□□□□6-□□□□	76.000

Vertical main circuit connection, top and bottom (breaking capacity S)

I	400	66	50	3WT8041-□□□□6-□□□□	58.000	3WT8045-□□□□6-□□□□	76.000
I	630	66	50	3WT8061-□□□□6-□□□□	58.000	3WT8065-□□□□6-□□□□	76.000
I	800	66	50	3WT8081-□□□□6-□□□□	58.000	3WT8085-□□□□6-□□□□	76.000
I	1000	66	50	3WT8101-□□□□6-□□□□	58.000	3WT8105-□□□□6-□□□□	76.000
I	1250	66	50	3WT8121-□□□□6-□□□□	58.000	3WT8125-□□□□6-□□□□	76.000
I	1600	66	50	3WT8161-□□□□6-□□□□	61.000	3WT8165-□□□□6-□□□□	79.000
II	630	66	66	3WT8062-□□□□6-□□□□	94.000	3WT8066-□□□□6-□□□□	118.000
II	800	66	66	3WT8082-□□□□6-□□□□	94.000	3WT8086-□□□□6-□□□□	118.000
II	1000	66	66	3WT8102-□□□□6-□□□□	94.000	3WT8106-□□□□6-□□□□	118.000
II	1250	66	66	3WT8122-□□□□6-□□□□	94.000	3WT8126-□□□□6-□□□□	118.000
II	1600	66	66	3WT8162-□□□□6-□□□□	94.000	3WT8166-□□□□6-□□□□	118.000
II	2000	66	66	3WT8202-□□□□6-□□□□	94.000	3WT8206-□□□□6-□□□□	118.000
II	2500	66	66	3WT8252-□□□□6-□□□□	94.000	3WT8256-□□□□6-□□□□	118.000
II	3200	66	66	3WT8322-□□□□6-□□□□	100.000	3WT8326-□□□□6-□□□□	124.000
II	3800	66	66	3WT8402-□□□□6-□□□□	118.000	3WT8406-□□□□6-□□□□	141.000

Electronic trip unit (ETU; 8th position of Article No.)

ETU35WT: LSI with LCD display
 ETU37WT: LSING²⁾ with LCD display
 ETU45WT: LSIN²⁾⁶⁾ with LCD display and additional features
 ETU47WT: LSING²⁾⁶⁾ with LCD display and additional features

Operating mechanism, auxiliary release, auxiliary switch (9th to 11th position of Article No., further options see page 2/25)

Manual operating mechanism, with mechanical closing, without 1st and 2nd auxiliary releases, with auxiliary switch 2 NO + 2 NC

Accessories (13th to 16th position of Article No., further options see pages 2/26 to 2/31)

with door sealing frame IP41,

with door sealing frame IP41, sealing cap over OFF button and shutter
 size I, up to 1600 A
 size II, 630 ... 3800 A

with door sealing frame IP41, safety lock device CES instead of OFF button³⁾ (key removable in OFF position); and shutter
 size I, up to 1600 A
 size II, 630 ... 3800 A

Article No. supplements	Additional price	Article No. supplements	Additional price
5	X	5	X
6	X	6	X
7	X	7	X
8	X	8	X
AA0	without	AA0	without
5AA2	without	5AA2	without
5AB2	X	5AB2	X
	X		X
5AF2	X	5AF2	X
	X		X

1) $I_{cw}/500\text{ V}$ 0.5 s for breaking capacity N.

2) Current transformer for overload protection in the neutral conductor and for ground-fault protection must be ordered separately, see page 2/32.

3) This disables mechanical or electrical ON commands.

4) Not available for circuit breakers without guide frame, see also page 2/26.

5) Can be converted to vertical at top and horizontal main connection at bottom.

6) ETU Release 2 prepared for communication and metering.

X = additional price

3WT Air Circuit Breakers up to 4000 A (AC)

3- and 4-pole, withdrawable version

Size	Rated current I_n	Short-circuit breaking capacity $I_{cu}/500\text{ V}$	Short-time withstand current, $I_{cw}/500\text{ V}$ 1 s ¹⁾	3-pole Article No. Article No. supplement (8th to 11th and 13th to 16th position of Article No.) must be added. For quick selection see below. Further options see pages 2/25 to 2/31.	Weight approx. kg	4-pole Article No. Article No. supplement (8th to 11th and 13th to 16th position of Article No.) must be added. For quick selection see below. Further options see pages 2/25 to 2/31.	Weight approx. kg
A	kA	kA	kA				
Without guide frame (breaking capacity N, guide frame see page 2/32)							
I	400	55	50	3WT8040-□□□□3-□□□□	36.000	3WT8044-□□□□3-□□□□	49.000
I	630	55	50	3WT8060-□□□□3-□□□□	36.000	3WT8064-□□□□3-□□□□	49.000
I	800	55	50	3WT8080-□□□□3-□□□□	36.000	3WT8084-□□□□3-□□□□	49.000
I	1000	55	50	3WT8100-□□□□3-□□□□	36.000	3WT8104-□□□□3-□□□□	49.000
I	1250	55	50	3WT8120-□□□□3-□□□□	36.000	3WT8124-□□□□3-□□□□	49.000
I	1600	55	50	3WT8160-□□□□3-□□□□	58.000	3WT8164-□□□□3-□□□□	76.000
Without guide frame (breaking capacity S, guide frame see page 2/32)							
I	400	66	50	3WT8041-□□□□3-□□□□	36.000	3WT8045-□□□□3-□□□□	49.000
I	630	66	50	3WT8061-□□□□3-□□□□	36.000	3WT8065-□□□□3-□□□□	49.000
I	800	66	50	3WT8081-□□□□3-□□□□	36.000	3WT8085-□□□□3-□□□□	49.000
I	1000	66	50	3WT8101-□□□□3-□□□□	36.000	3WT8105-□□□□3-□□□□	49.000
I	1250	66	50	3WT8121-□□□□3-□□□□	36.000	3WT8125-□□□□3-□□□□	49.000
I	1600	66	50	3WT8161-□□□□3-□□□□	38.000	3WT8165-□□□□3-□□□□	51.000
II	630	66	66	3WT8062-□□□□3-□□□□	94.000	3WT8066-□□□□3-□□□□	118.000
II	800	66	66	3WT8082-□□□□3-□□□□	94.000	3WT8086-□□□□3-□□□□	118.000
II	1000	66	66	3WT8102-□□□□3-□□□□	94.000	3WT8106-□□□□3-□□□□	118.000
II	1250	66	66	3WT8122-□□□□3-□□□□	94.000	3WT8126-□□□□3-□□□□	118.000
II	1600	66	66	3WT8162-□□□□3-□□□□	94.000	3WT8166-□□□□3-□□□□	118.000
II	2000	66	66	3WT8202-□□□□3-□□□□	59.000	3WT8206-□□□□3-□□□□	72.000
II	2500	66	66	3WT8252-□□□□3-□□□□	59.000	3WT8256-□□□□3-□□□□	72.000
II	3200	66	66	3WT8322-□□□□3-□□□□	63.000	3WT8326-□□□□3-□□□□	76.000

Electronic trip unit (ETU; 8th position of Article No.)

ETU35WT: LSI with LCD display
 ETU37WT: LSING²⁾ with LCD display
 ETU45WT: LSIN²⁾⁶⁾ with LCD display and additional features
 ETU47WT: LSING²⁾⁶⁾ with LCD display and additional features

Operating mechanism, auxiliary release, auxiliary switch (9th to 11th position of Article No., further options see page 2/25)

Manual operating mechanism, with mechanical closing, without 1st and 2nd auxiliary releases, with auxiliary switch 2 NO + 2 NC

Accessories (13th to 16th position of Article No., further options see pages 2/26 to 2/31)

with door sealing frame IP41,
 with door sealing frame IP41, sealing cap over OFF button and shutter size I, up to 1600 A
 size II, 630 ... 3800 A
 with door sealing frame IP41, safety lock device CES instead of OFF button³⁾ (key removable in OFF position); and shutter size I, up to 1600 A
 size II, 630 ... 3800 A

Article No. supplements	Additional price	Article No. supplements	Additional price
5	X	5	X
6	X	6	X
7	X	7	X
8	X	8	X
AA0	without	AA0	without
5AA2	without	5AA2	without
4) 5AB2	X	4) 5AB2	X
	X		X
4) 5AF2	X	4) 5AF2	X
	X		X

1) $I_{cw}/500\text{ V}$ 0.5 s for breaking capacity N.
 2) Current transformer for overload protection in the neutral conductor and for ground-fault protection must be ordered separately, see page 2/32.
 3) This disables mechanical or electrical ON commands.
 4) Not available for circuit breakers without guide frame, see also page 2/26.
 5) Can be converted to vertical at top and horizontal main connection at bottom.
 6) ETU Release 2 prepared for communication and metering.

X = additional price

3WT Air Circuit Breakers up to 4000 A (AC)

3- and 4-pole, fixed-mounted version

Selection and ordering data

Size	Rated current I_n	Short-circuit breaking capacity $I_{cu}/500\text{ V}$	Short-time withstand current, $I_{cw}/500\text{ V}$ (1 s ¹⁾)	3-pole		4-pole	
				Article No.	Weight approx.	Article No.	Weight approx.
				Article No. supplement (8th to 11th and 13th to 16th position of Article No.) must be added. For quick selection see below. Further options see pages 2/25 to 2/31.	kg	Article No. supplement (8th to 11th and 13th to 16th position of Article No.) must be added. For quick selection see below. Further options see pages 2/25 to 2/31.	kg
A	kA	kA	kA				
Horizontal main circuit connection (breaking capacity N)							
I	400	55	50	3WT8040-□□□□0-□□□□	34.000	3WT8044-□□□□0-□□□□	47.000
I	630	55	50	3WT8060-□□□□0-□□□□	34.000	3WT8064-□□□□0-□□□□	47.000
I	800	55	50	3WT8080-□□□□0-□□□□	34.000	3WT8084-□□□□0-□□□□	47.000
I	1000	55	50	3WT8100-□□□□0-□□□□	34.000	3WT8104-□□□□0-□□□□	47.000
I	1250	55	50	3WT8120-□□□□0-□□□□	34.000	3WT8124-□□□□0-□□□□	47.000
I	1600	55	50	3WT8160-□□□□0-□□□□	34.000	3WT8164-□□□□0-□□□□	47.000
Horizontal main circuit connection (breaking capacity S)							
I	400	66	50	3WT8041-□□□□0-□□□□	34.000	3WT8045-□□□□0-□□□□	47.000
I	630	66	50	3WT8061-□□□□0-□□□□	34.000	3WT8065-□□□□0-□□□□	47.000
I	800	66	50	3WT8081-□□□□0-□□□□	34.000	3WT8085-□□□□0-□□□□	47.000
I	1000	66	50	3WT8101-□□□□0-□□□□	34.000	3WT8105-□□□□0-□□□□	47.000
I	1250	66	50	3WT8121-□□□□0-□□□□	34.000	3WT8125-□□□□0-□□□□	47.000
I	1600	66	50	3WT8161-□□□□0-□□□□	36.000	3WT8165-□□□□0-□□□□	49.000
II	630	66	66	3WT8062-□□□□0-□□□□	57.000	3WT8066-□□□□0-□□□□	70.000
II	800	66	66	3WT8082-□□□□0-□□□□	57.000	3WT8086-□□□□0-□□□□	70.000
II	1000	66	66	3WT8102-□□□□0-□□□□	57.000	3WT8106-□□□□0-□□□□	70.000
II	1250	66	66	3WT8122-□□□□0-□□□□	57.000	3WT8126-□□□□0-□□□□	70.000
II	1600	66	66	3WT8162-□□□□0-□□□□	57.000	3WT8166-□□□□0-□□□□	70.000
II	2000	66	66	3WT8202-□□□□0-□□□□	57.000	3WT8206-□□□□0-□□□□	70.000
II	2500	66	66	3WT8252-□□□□0-□□□□	57.000	3WT8256-□□□□0-□□□□	70.000
II	3200	66	66	3WT8322-□□□□0-□□□□	61.000	3WT8326-□□□□0-□□□□	74.000
Vertical main circuit connection (breaking capacity S)							
II	4000	66	66	3WT8402-□□□□2-□□□□	92.000	3WT8406-□□□□2-□□□□	106.000
Electronic trip unit (ETU; 8th position of Article No.)				Article No. supple- ments	Additional price	Article No. supple- ments	Additional price
ETU35WT: LSI with LCD display				5	X	5	X
ETU37WT: LSING ²⁾ with LCD display				6	X	6	X
ETU45WT: LSIN ²⁾⁴⁾ with LCD display and additional features				7	X	7	X
ETU47WT: LSING ²⁾⁴⁾ with LCD display and additional features				8	X	8	X
Operating mechanism, auxiliary release, auxiliary switch (9th to 11th position of Article No., further options see page 2/25)							
Manual operating mechanism, with mechanical closing, without 1st and 2nd auxiliary releases, with auxiliary switch 2 NO + 2 NC				AA0	without	AA0	without
Motor operated mechanism, with mechanical and electrical closing, motor and closing solenoid 220-240 V AC 50/60 Hz, 220-250 V DC,				UA3	X	UA3	X
Shunt release "F" 220-240 V AC 50/60 Hz, 220-250 V DC							
without 2nd auxiliary release, with auxiliary switch 2 NO + 2 NC							
Motor operated mechanism, with mechanical and electrical closing, motor and closing solenoid 220-240 V AC 50/60 Hz, 220-250 V DC,				UN3	X	UN3	X
Undervoltage release "r", "F3" 220-240 V AC 50/60 Hz, 220-250 V DC							
Shunt release "F" 220-240 V AC 50/60 Hz, 220-250 V DC							
with auxiliary switch 2 NO + 2 NC							
Accessories (13th to 16th position of Article No., further options see pages 2/26 to 2/31)							
with door sealing frame IP41				0AA2	without	0AA2	without
with door sealing frame IP41, safety lock device CES instead of OFF button ³⁾ (key removable in OFF position)				0AB2	X	0AB2	X
with door sealing frame IP41, sealing cap over OFF button and mutual mechanical interlock for 3WT circuit breaker				0AC2	X	0AC2	X

1) $I_{cw}/500\text{ V}$ 0.5 s for breaking capacity N.

2) Current transformer for overload protection in the neutral conductor and for ground-fault protection must be ordered separately, see page 2/32.

3) This disables mechanical or electrical ON commands.

4) ETU Release 2 prepared for communication and metering.

X = additional price

3WT Air Circuit-Breakers up to 4000 A (AC)

Non-automatic air circuit-breakers, 3- and 4-pole, withdrawable version

Selection and ordering data

Size	Rated current I_n	Short-circuit breaking capacity $I_{cc}/500\text{ V}$	3-pole		Weight approx. kg	4-pole		Weight approx. kg
			Article No. Article No. supplement (8th to 11th and 13th to 16th position of Article No.) must be added. For quick selection see below. Further options see pages 2/25 to 2/31.			Article No. Article No. supplement (8th to 11th and 13th to 16th position of Article No.) must be added. For quick selection see below. Further options see pages 2/25 to 2/31.		
A		kA						
Withdrawable version, horizontal main circuit connection (breaking capacity S)								
I	800	55	3WT8080-4□□□4-□□□□		58.000	3WT8084-4□□□4-□□□□		76.000
I	1250	55	3WT8120-4□□□4-□□□□		58.000	3WT8124-4□□□4-□□□□		76.000
I	1600	66	3WT8161-4□□□4-□□□□		61.000	3WT8165-4□□□4-□□□□		79.000
II	2000	66	3WT8202-4□□□4-□□□□		94.000	3WT8206-4□□□4-□□□□		118.000
II	2500	66	3WT8252-4□□□4-□□□□		94.000	3WT8256-4□□□4-□□□□		118.000
II	3200	66	3WT8322-4□□□4-□□□□		100.000	3WT8326-4□□□4-□□□□		124.000
Withdrawable version, horizontal main circuit connection at top, vertical connection at bottom¹⁾ (breaking capacity S)								
I	800	55	3WT8080-4□□□8-□□□□		58.000	3WT8084-4□□□8-□□□□		76.000
I	1250	55	3WT8120-4□□□8-□□□□		58.000	3WT8124-4□□□8-□□□□		76.000
I	1600	66	3WT8161-4□□□8-□□□□		61.000	3WT8165-4□□□8-□□□□		79.000
II	2000	66	3WT8202-4□□□8-□□□□		94.000	3WT8206-4□□□8-□□□□		118.000
II	2500	66	3WT8252-4□□□8-□□□□		94.000	3WT8256-4□□□8-□□□□		118.000
II	3200	66	3WT8322-4□□□8-□□□□		100.000	3WT8326-4□□□8-□□□□		124.000
Withdrawable version, vertical connection at top and bottom (breaking capacity S)								
I	800	55	3WT8080-4□□□6-□□□□		58.000	3WT8084-4□□□6-□□□□		76.000
I	1250	55	3WT8120-4□□□6-□□□□		58.000	3WT8124-4□□□6-□□□□		76.000
I	1600	66	3WT8161-4□□□6-□□□□		61.000	3WT8165-4□□□6-□□□□		79.000
II	2000	66	3WT8202-4□□□6-□□□□		94.000	3WT8206-4□□□6-□□□□		118.000
II	2500	66	3WT8252-4□□□6-□□□□		94.000	3WT8256-4□□□6-□□□□		118.000
II	3200	66	3WT8322-4□□□6-□□□□		100.000	3WT8326-4□□□6-□□□□		124.000
II	3800	66	3WT8402-4□□□6-□□□□		100.000	3WT8406-4□□□6-□□□□		141.000
Withdrawable version without guide frame (breaking capacity S, guide frame see page 2/32)								
I	800	55	3WT8080-4□□□3-□□□□		36.000	3WT8084-4□□□3-□□□□		49.000
I	1250	55	3WT8120-4□□□3-□□□□		36.000	3WT8124-4□□□3-□□□□		49.000
I	1600	66	3WT8161-4□□□3-□□□□		38.000	3WT8165-4□□□3-□□□□		51.000
II	2000	66	3WT8202-4□□□3-□□□□		59.000	3WT8206-4□□□3-□□□□		72.000
II	2500	66	3WT8252-4□□□3-□□□□		59.000	3WT8256-4□□□3-□□□□		72.000
II	3200	66	3WT8322-4□□□3-□□□□		63.000	3WT8326-4□□□3-□□□□		76.000

Operating mechanism, auxiliary release, auxiliary switch (9th to 11th position of Article No., further options see page 2/25)

Manual operating mechanism, with mechanical closing, without 1st and 2nd auxiliary releases, with auxiliary switch 2 NO + 2 NC

Motor operated mechanism, with mechanical and electrical closing, motor and closing solenoid 220-240 V AC 50/60 Hz, 220-250 V DC, Shunt release "F" 220-240 V AC 50/60 Hz, 220-250 V DC

without 2nd auxiliary release, with auxiliary switch 2 NO + 2 NC

Withdrawable version Accessories (13th to 16th position of Article No., further options see pages 2/26 to 2/31)

with door sealing frame IP41

with door sealing frame IP41, sealing cap over OFF button, and shutter size I, up to 1600 A size II, 630 ... 3800 A

Article No. supplements

AA0

without

UA3

X

5AA2

without

5AB2

X

X

Article No. supplements

AA0

without

UA3

X

5AA2

without

5AB2

X

X

"Options" and "Accessories" see "Options" and "Accessories" for "Air-Circuit Breakers", pages 2/25 to 2/36.

¹⁾ Can be converted to vertical at top and horizontal main connection at bottom.

X = additional price

3WT Air Circuit-Breakers up to 4000 A (AC)

Non-automatic air circuit-breakers, 3- and 4-pole, fixed-mounted version

Selection and ordering data

Size	Rated current I_n	Short-circuit breaking capacity $I_{cc}/500\text{ V}$	3-pole		Weight approx. kg	4-pole		Weight approx. kg
			Article No. Article No. supplement (8th to 11th and 13th to 16th position of Article No.) must be added. For quick selection see below. Further options see pages 2/25 to 2/31.			Article No. Article No. supplement (8th to 11th and 13th to 16th position of Article No.) must be added. For quick selection see below. Further options see pages 2/25 to 2/31.		
A		kA						

Fixed-mounted version, horizontal main circuit connection (breaking capacity S)

I	800	55	3WT8080-4 □□□□0-□□□□	34.000	3WT8084-4 □□□□0-□□□□	47.000
I	1250	55	3WT8120-4 □□□□0-□□□□	34.000	3WT8124-4 □□□□0-□□□□	47.000
I	1600	66	3WT8161-4 □□□□0-□□□□	36.000	3WT8165-4 □□□□0-□□□□	49.000
II	2000	66	3WT8202-4 □□□□0-□□□□	57.000	3WT8206-4 □□□□0-□□□□	70.000
II	2500	66	3WT8252-4 □□□□0-□□□□	57.000	3WT8256-4 □□□□0-□□□□	70.000
II	3200	66	3WT8322-4 □□□□0-□□□□	61.000	3WT8326-4 □□□□0-□□□□	74.000

Fixed-mounted version, vertical main circuit connection (breaking capacity S)

II	4000	66	3WT8402-4 □□□□2-□□□□	92.000	3WT8406-4 □□□□2-□□□□	106.000
----	------	----	-----------------------------	--------	-----------------------------	---------

Operating mechanism, auxiliary release, auxiliary switch (9th to 11th position of Article No., further options see page 2/25)

Manual operating mechanism,
with mechanical closing,
without 1st and 2nd auxiliary releases,
with auxiliary switch 2 NO + 2 NC

Motor operated mechanism,
with mechanical and electrical closing,
motor and closing solenoid 220-240 V AC 50/60 Hz,
220-250 V DC,
Shunt release "F" 220-240 V AC 50/60 Hz,
220-250 V DC

without 2nd auxiliary release,
with auxiliary switch 2 NO + 2 NC

Fixed-mounted version Accessories (13th to 16th position of Article No., further options see pages 2/26 to 2/31)

with door sealing frame IP41

Withdrawable version

Accessories (13th to 16th position of Article No., further options see pages 2/26 to 2/31)

with door sealing frame IP41

with door sealing frame IP41, sealing cap over OFF button,
and shutter size I, up to 1600 A
size II, 630 ... 3800 A

Article No.
supple-
ments

AA0
UA3

Additional
price

without

X

without

without

X

X

Article No.
supple-
ments

AA0
UA3

Additional
price

without

X

without

without

X

X

"Options" and "Accessories" see "Options" and "Accessories" for
"Air-Circuit Breakers", pages 2/25 to 2/36.

X = additional price



Selection and ordering data

Design	Article No. supplement	Additional price		
	9th to 11th position of Article No. of circuit breaker (see pages 2/19 to 2/24) must be added as listed below 3WT8 . . . - □ □ □ . -			
Operating mechanism				
Manual operating mechanism, with mechanical closing	A	without		
Manual operating mechanism, with mechanical and electrical closing				
Closing solenoid				
AC 50/60 Hz V	DC V			
--	24			
110 ... 127	110 ... 125	X		
220 ... 240	220 ... 250	X		
	B			
	E	X		
	F	X		
Manual/motorized operating mechanism, with mechanical and electrical closing				
Motor	Closing solenoid			
AC 50/60 Hz V	DC V	AC 50/60 Hz V	DC V	
--	24	24	24	
110 ... 127	110 ... 125	110 ... 127	110 ... 125	X
220 ... 240	220 ... 250	220 ... 240	220 ... 250	X
110 ... 127	110 ... 125	--	24	X
220 ... 240	220 ... 250	--	24	X
220 ... 240	220 ... 250	110 ... 127	110 ... 125	X
		G		
		K		
		U		
		L		
		Q		
		T		
1st auxiliary release				
Without 1st auxiliary release	A	without		
Shunt release "f" F1				
AC 50/60 Hz V	DC V			
--	24			
110 ... 127	110 ... 125	X		
220 ... 240	220 ... 250	X		
		B		
		F		
		G		
Undervoltage release "r" F3				
AC 50/60 Hz V	DC V			
--	24			
110 ... 127	110 ... 125	X		
220 ... 240	220 ... 250	X		
380 ... 415	--	X		
		H		
		M		
		N		
		P		
Undervoltage release "rc" F8, can be delayed between 0.2 and 3.2 s				
AC 50/60 Hz V	DC V			
110 ... 127	110 ... 125	X		
220 ... 240	220 ... 250	X		
380 ... 415	--	X		
		U		
		V		
		W		
2nd auxiliary release and auxiliary switch				
Without 2nd auxiliary release	with 1st auxiliary contact block (standard) 2 NO + 2 NC	0	without	
Shunt release "f" F2	with 1st auxiliary contact block (standard)			
AC 50/60 Hz V	DC V			
--	24	2 NO + 2 NC	X	
110 ... 127	110 ... 125	2 NO + 2 NC	X	
220 ... 240	220 ... 250	2 NO + 2 NC	X	
		1		
		2		
		3		
Without 2nd auxiliary release	with 1st and 2nd auxiliary contact block 2 NO + 2 NC + 2 CO	4	X	
Shunt release "f" F2	with 1st and 2nd auxiliary contact block			
AC 50/60 Hz V	DC V			
--	24	2 NO + 2 NC + 2 CO	X	
110 ... 127	110 ... 125	2 NO + 2 NC + 2 CO	X	
220 ... 240	220 ... 250	2 NO + 2 NC + 2 CO	X	
		5		
		6		
		7		

X = additional price



3WT Air Circuit Breakers up to 4000 A (AC)

Options

Design	Article No. supplement 13th to 16th position of Article No. of circuit breaker (see pages 2/19 to 2/22) must be added as listed below	Additional price	
		3-pole	4-pole
	3WT8 . . . - - <input type="checkbox"/> <input type="checkbox"/> <input type="checkbox"/> <input type="checkbox"/>		
For withdrawable circuit breakers without guide frame			
	With door sealing frame IP41	5 A A 2	without without
	With door sealing frame IP41 and locking device With safety lock device CES instead of OFF button ¹⁾ (key removable in OFF position)	5 A E 2	X X
For withdrawable circuit breakers with guide frame			
	With door sealing frame IP41	5 A A 2	without without
	With door sealing frame IP41, sealing cap over OFF button, and shutter Sealing cap to prevent unauthorized opening, cannot be combined with safety lock With shutter Size I, up to 1600 A Size II, 630 ... 3800 A	5 A B 2	X X X X
	With door sealing frame IP41, sealing cap over OFF button, and mutual mechanical interlock for 3WT circuit breaker Sealing cap to prevent unauthorized opening, cannot be combined with safety lock Interlock module with a Bowden wire (2 m); when interlocking three circuit breakers an additional Bowden wire is required, see page 2/33.	5 A C 2	X X
	With door sealing frame IP41, sealing cap over OFF button, mutual mechanical interlock for 3WT circuit breaker and shutter Sealing cap to prevent unauthorized opening, cannot be combined with safety lock Interlock module with a Bowden wire (2 m); when interlocking three circuit breakers an additional Bowden wire is required, see page 2/33. With shutter Size I, up to 1600 A Size II, 630 ... 3800 A	5 A D 2	X X X X
	With door sealing frame IP41 and locking device With safety lock device CES instead of OFF button ¹⁾ (key removable in OFF position)	5 A E 2	X X
	With door sealing frame IP41, locking device, and shutter With safety lock device CES instead of OFF button ¹⁾ (key removable in OFF position) With shutter Size I, up to 1600 A Size II, 630 ... 3800 A	5 A F 2	X X X X
	With door sealing frame IP41 locking device, blocking device and mutual mechanical interlock for 3WT circuit breaker With safety lock device CES instead of OFF button ¹⁾ (key removable in OFF position) Blocking device to prevent opening of the cabinet door when the circuit breaker is in connected position Interlock module with a Bowden wire (2 m); when interlocking three circuit breakers an additional Bowden wire is required, see page 2/33.	5 A G 2	X X
	With door sealing frame IP41 locking device, blocking device, mutual mechanical interlock for 3WT circuit breaker and shutter With safety lock device CES instead of OFF button ¹⁾ (key removable in OFF position) Blocking device to prevent opening of the cabinet door when the circuit breaker is in connected position Interlock module with a Bowden wire (2 m); when interlocking three circuit breakers an additional Bowden wire is required, see page 2/33. With shutter Size I, up to 1600 A Size II, 630 ... 3800 A	5 A H 2	X X X X

¹⁾ This disables mechanical or electrical ON commands.

X = additional price



Design	Article No. supplement 13th to 16th position of Article No. of circuit breaker (see pages 2/19 to 2/24) must be added as listed below	Additional price	
		3-pole	4-pole
3WT8 . . . - - □ □ □ □			
For withdrawable circuit breakers with guide frame			
	With door sealing frame IP41 locking device and sealing cap over OFF button Locking device: mounting set for CASTELL lock ¹⁾ , Interlock to be obtained from the manufacturer of the locks CASTELL lock (FS 2)	5 A J 2	
	Sealing cap to prevent unauthorized opening, cannot be combined with safety lock		X X
	With door sealing frame IP41 locking device, sealing cap over OFF button, and shutter Locking device: mounting set for CASTELL lock ¹⁾ , Interlock to be obtained from the manufacturer of the locks CASTELL lock (FS 2) Sealing cap to prevent unauthorized opening, cannot be combined with safety lock With shutter Size I, up to 1600 A Size II, 630 ... 3800 A	5 A K 2	X X
	With door sealing frame IP41 locking device, blocking device, sealing cap over OFF button and mutual mechanical interlock for 3WT circuit breaker Locking device: mounting set for CASTELL lock ¹⁾ , Interlock to be obtained from the manufacturer of the locks CASTELL lock (FS 2) Blocking device to prevent opening of the cabinet door when the circuit breaker is in connected position Sealing cap to prevent unauthorized opening, cannot be combined with safety lock Interlock module with a Bowden wire (2 m); when interlocking three circuit breakers an additional Bowden wire is required, see page 2/33.	5 A L 2	X X
	With door sealing frame IP41 locking device, blocking device, sealing cap over OFF button, mutual mechanical interlock for 3WT circuit breaker and shutter Locking device: mounting set for CASTELL lock ¹⁾ , Interlock to be obtained from the manufacturer of the locks CASTELL lock (FS 2) Blocking device to prevent opening of the cabinet door when the circuit breaker is in connected position Sealing cap to prevent unauthorized opening, cannot be combined with safety lock Interlock module with a Bowden wire (2 m); when interlocking three circuit breakers an additional Bowden wire is required, see page 2/33. With shutter Size I, up to 1600 A Size II, 630 ... 3800 A	5 A M 2	X X
	With door sealing frame IP41, sealing cap over OFF button, 5-digit operating cycles counter and shutter Sealing cap to prevent unauthorized opening, cannot be combined with safety lock With shutter Size I, up to 1600 A Size II, 630 ... 3800 A	5 A P 2	X X
	With door sealing frame IP41 blocking device, sealing cap over OFF button, 5-digit operating cycles counter and mutual mechanical interlock for 3WT circuit breaker Blocking device to prevent opening of the cabinet door when the circuit breaker is in connected position Sealing cap to prevent unauthorized opening, cannot be combined with safety lock Interlock module with a Bowden wire (2 m); when interlocking three circuit breakers an additional Bowden wire is required, see page 2/33.	5 A Q 2	X X

¹⁾ Locks are available at the manufacturer of the locks or 3WT lock, interlock system 2 identical keys for 3 circuit breakers.

X = additional price

3WT Air Circuit Breakers up to 4000 A (AC)

Options



Design	Article No. supplement	Additional price						
	13th to 16th position of Article No. of circuit breaker (see pages 2/19 to 2/24) must be added as listed below	3-pole	4-pole					
	3WT8...-.....-□□□□							
For withdrawable circuit breakers with guide frame								
  	With door sealing frame IP41 locking device, sealing cap over OFF button, 5-digit operating cycles counter mutual mechanical interlock for 3WT circuit breaker, and shutter Blocking device to prevent opening of the cabinet door when the circuit breaker is in connected position Sealing cap to prevent unauthorized opening, cannot be combined with safety lock Interlock module with a Bowden wire (2 m); when interlocking three circuit breakers an additional Bowden wire is required, see page 2/33. With shutter Size I, up to 1600 A Size II, 630 ... 3800 A	5	A	R	2			
	With door sealing frame IP41 locking device, sealing cap over OFF button and 5-digit operating cycles counter Locking device: mounting set for CASTELL lock ¹⁾ , Interlock to be obtained from the manufacturer of the locks CASTELL lock (FS 2) Sealing cap to prevent unauthorized opening, cannot be combined with safety lock						X	X
	With door sealing frame IP41 locking device, sealing cap over OFF button, 5-digit operating cycles counter and shutter Locking device: mounting set for CASTELL lock ¹⁾ , Interlock to be obtained from the manufacturer of the locks CASTELL lock (FS 2) Sealing cap to prevent unauthorized opening, cannot be combined with safety lock With shutter Size I, up to 1600 A Size II, 630 ... 3800 A						X	X
	With door sealing frame IP41 locking device, blocking device, sealing cap over OFF button, 5-digit operating cycles counter and mutual mechanical interlock for 3WT circuit breaker Locking device: mounting set for CASTELL lock ¹⁾ , Interlock to be obtained from the manufacturer of the locks CASTELL lock (FS 2) Blocking device to prevent opening of the cabinet door when the circuit breaker is in connected position Sealing cap to prevent unauthorized opening, cannot be combined with safety lock Interlock module with a Bowden wire (2 m); when interlocking three circuit breakers an additional Bowden wire is required, see page 2/33.						X	X
	With door sealing frame IP41 locking device, blocking device, sealing cap over OFF button, 5-digit operating cycles counter mutual mechanical interlock for 3WT circuit breaker and shutter Locking device: mounting set for CASTELL lock ¹⁾ , Interlock to be obtained from the manufacturer of the locks CASTELL lock (FS 2) Blocking device to prevent opening of the cabinet door when the circuit breaker is in connected position Sealing cap to prevent unauthorized opening, cannot be combined with safety lock Interlock module with a Bowden wire (2 m); when interlocking three circuit breakers an additional Bowden wire is required, see page 2/33. With shutter Size I, up to 1600 A Size II, 630 ... 3800 A						X	X
	With door sealing frame IP41 locking device, blocking device, sealing cap over OFF button, 5-digit operating cycles counter and mutual mechanical interlock for 3WT circuit breaker Locking device: mounting set for CASTELL lock ¹⁾ , Interlock to be obtained from the manufacturer of the locks CASTELL lock (FS 2) Blocking device to prevent opening of the cabinet door when the circuit breaker is in connected position Sealing cap to prevent unauthorized opening, cannot be combined with safety lock						X	X

¹⁾ Locks are available at the manufacturer of the locks or 3WT lock, interlock system 2 identical keys for 3 circuit breakers.

X = additional price

3WT Air Circuit Breakers up to 4000 A (AC)

Options



Design	Article No. supplement 13th to 16th position of Article No. of circuit breaker (see pages 2/19 to 2/24) must be added as listed below	Additional price	
		3-pole	4-pole
3WT8 . . . - - □ □ □ □			
For withdrawable circuit breakers with guide frame			
	With door interlock	5 A W 2	X X
	With door interlock and shutter With shutter Size I, up to 1600 A Size II, 630 ... 3800 A	5 A X 2	X X X X
	With door interlock, locking device, sealing cap over OFF button, position indicator switch and shutter Locking device: mounting set for CASTELL lock ¹⁾ , Interlock to be obtained from the manufacturer of the locks CASTELL lock (FS 2) Sealing cap to prevent unauthorized opening, cannot be combined with safety lock With shutter Size I, up to 1600 A Size II, 630 ... 3800 A	5 A Y 2	X X X X
	With door interlock, sealing cap over OFF button, position indicator switch, 5-digit operating cycles counter and shutter Sealing cap to prevent unauthorized opening, cannot be combined with safety lock With shutter Size I, up to 1600 A Size II, 630 ... 3800 A	5 B A 2	X X X X
	With door interlock, locking device, sealing cap over OFF button, position indicator switch, 5-digit operating cycles counter and shutter Locking device: mounting set for CASTELL lock ¹⁾ , Interlock to be obtained from the manufacturer of the locks CASTELL lock (FS 2) Sealing cap to prevent unauthorized opening, cannot be combined with safety lock With shutter Size I, up to 1600 A Size II, 630 ... 3800 A	5 B B 2	X X X X
	With door interlock, sealing cap over OFF button, position indicator switch and shutter Sealing cap to prevent unauthorized opening, cannot be combined with safety lock With shutter Size I, up to 1600 A Size II, 630 ... 3800 A	5 B C 2	X X X X

¹⁾ Locks are available at the manufacturer of the locks or 3WT lock, interlock system 2 identical keys for 3 circuit breakers.

X = additional price



3WT Air Circuit Breakers up to 4000 A (AC)

Options

Design	Article No. supplement 13th to 16th position of Article No. of circuit breaker (see pages 2/19 to 2/24) must be added as listed below	Additional price	
		3-pole	4-pole
3WT8 - □ □ □ □			
For fixed-mounted circuit breakers			
	With door sealing frame IP41	0 A A 2	without without
	With door sealing frame IP41 and locking device With safety lock device CES instead of OFF button ¹⁾ (key removable in OFF position)	0 A B 2	X X
	With door sealing frame IP41, sealing cap over OFF button and mutual mechanical interlock for 3WT circuit breaker, sealing cap to prevent unauthorized opening, cannot be combined with safety lock Interlock module with a Bowden wire (2 m); when interlocking three circuit breakers an additional Bowden wire is required, see page 2/33.	0 A C 2	X X
	With door sealing frame IP41, locking device, and mutual mechanical interlock for 3WT circuit breaker With safety lock device CES instead of OFF button ¹⁾ (key removable in OFF position) Interlock module with a Bowden wire (2 m); when interlocking three circuit breakers an additional Bowden wire is required, see page 2/33.	0 A D 2	X X
	With door sealing frame IP41, sealing cap over OFF button, blocking device, and mutual mechanical interlock for 3WT circuit breaker Sealing cap to prevent unauthorized opening, cannot be combined with safety lock Blocking device to prevent opening of the cabinet door with the circuit breaker closed Interlock module with a Bowden wire (2 m); when interlocking three circuit breakers an additional Bowden wire is required, see page 2/33.	0 A E 2	X X
	With door sealing frame IP41, locking device, blocking device, and mutual mechanical interlock for 3WT circuit breaker With safety lock device CES instead of OFF button ¹⁾ (key removable in OFF position) Blocking device to prevent opening of the cabinet door with the circuit breaker closed Interlock module with a Bowden wire (2 m); when interlocking three circuit breakers an additional Bowden wire is required, see page 2/33.	0 A F 2	X X
	With door sealing frame IP41, locking device, and sealing cap over OFF button Locking device: mounting set for CASTELL lock ²⁾ ; Interlock to be obtained from the manufacturer of the locks CASTELL lock (FS 2) Sealing cap to prevent unauthorized opening, cannot be combined with safety lock	0 A G 2	X X
	With door sealing frame IP41, 5-digit operating cycles counter, locking device, sealing cap over OFF button, blocking device, and mutual mechanical interlock for 3WT circuit breaker Locking device: mounting set for CASTELL lock ²⁾ ; Interlock to be obtained from the manufacturer of the locks CASTELL lock (FS 2) Sealing cap to prevent unauthorized opening, cannot be combined with safety lock Blocking device to prevent opening of the cabinet door with the circuit breaker closed Interlock module with a Bowden wire (2 m); when interlocking three circuit breakers an additional Bowden wire is required, see page 2/33.	0 A H 2	X X
	With door sealing frame IP41, 5-digit operating cycles counter, sealing cap over OFF button, and mutual mechanical interlock for 3WT circuit breaker Sealing cap to prevent unauthorized opening, cannot be combined with safety lock Interlock module with a Bowden wire (2 m); when interlocking three circuit breakers an additional Bowden wire is required, see page 2/33.	0 A J 2	X X

X = additional price

¹⁾ This disables mechanical or electrical ON commands.²⁾ Locks are available at the manufacturer of the locks or 3WT lock, interlock system 2 identical keys for 3 circuit breakers.

Design	Article No. supplement	Additional price	
	13th to 16th position of Article No. of circuit breaker (see pages 2/19 to 2/24) must be added as listed below	3-pole	4-pole
	3WT8 □ □ □ □		
For fixed-mounted circuit breakers			
	With door sealing frame IP41, 5-digit operating cycles counter, sealing cap over OFF button, blocking device, and mutual mechanical interlock for 3WT circuit breaker Sealing cap to prevent unauthorized opening, cannot be combined with safety lock Blocking device to prevent opening of the cabinet door with the circuit breaker closed Interlock module with a Bowden wire (2 m); when interlocking three circuit breakers an additional Bowden wire is required, see page 2/33.	0 A K 2	
	With door sealing frame IP41, 5-digit operating cycles counter, locking device, and sealing cap over OFF button Locking device: mounting set for CASTELL lock ²⁾ , Interlock to be obtained from the manufacturer of the locks CASTELL lock (FS 2) Sealing cap to prevent unauthorized opening, cannot be combined with safety lock	0 A L 2	X X
	With door sealing frame IP41, 5-digit operating cycles counter, locking device, sealing cap over OFF button, and mutual mechanical interlock for 3WT circuit breaker With safety lock device CES instead of OFF button ¹⁾ (key removable in OFF position) Locking device: mounting set for CASTELL lock ²⁾ , Interlock to be obtained from the manufacturer of the locks CASTELL lock (FS 2) Blocking device to prevent opening of the cabinet door with the circuit breaker closed Interlock module with a Bowden wire (2 m); when interlocking three circuit breakers an additional Bowden wire is required, see page 2/33.	0 A M 2	X X
	With 5-digit operating cycles counter	0 A N 2	X X
	With door interlock	0 A P 2	X X

¹⁾ This disables mechanical or electrical ON commands.

X = additional price

²⁾ Locks are available at the manufacturer of the locks or 3WT lock, interlock system 2 identical keys for 3 circuit breakers.

Add "-Z" to complete Article No. and indicate the appropriate order code(s).			3WT.....-Z
			□ □ □ +...+...
Rated operating voltage U_e¹⁾			
Conditions	Size	Rated current I_n	
Rated operating voltage U_e 690 V AC with I_{CS} , I_{CU} , I_{CW} = 50 kA, only for S class	I and II	Up to 3200 A	A 0 4
Rated operating voltage U_e 690 V AC with I_{CS} , I_{CU} , I_{CW} = 66 kA, only for S class	II	Up to 2500 A	A 0 8
Auxiliary contact block²⁾			
Conditions	Size	Rated current I_n	
1 st and 2 nd auxiliary contact block with 4 NO + 4 NC	I and II	Up to 4000 A	A 0 1
1 st and 2 nd auxiliary contact block with 5 NO + 3 NC	I and II	Up to 4000 A	A 1 1
1 st and 2 nd auxiliary contact block with 6 NO + 2 NC	I and II	Up to 4000 A	A 2 1
Phase barrier			
Conditions	Size	Rated current I_n	
3- or 4-pole	I and II	Up to 4000 A	A 3 0
Automatic mechanical resetting device			
Conditions	Size	Rated current I_n	
Automatic mechanical resetting device after overcurrent tripping	I and II	Up to 4000 A	K 0 1
Arc chute cover			
Conditions	Size	Rated current I_n	
For guide frames of withdrawable breaker	I and II	Up to 4000 A	R 1 0
Communication NEW			
Conditions	Size	ETU	
COM16WT – Modbus RTU, incl. BSSWT	I and II	ETU45/47WT	F 1 2
Meterings NEW			
Conditions	Size	ETU	
Metering with internal voltage tap on the lower main contacts	I and II	ETU45/47WT	F 0 5

¹⁾ Standard rated operating voltage U_e is 500 V AC.

²⁾ Only possible together with the 1st auxiliary contact block. 11th digit of the article number needs 0 - 3.

3WT Air Circuit Breakers up to 4000 A (AC)

Accessories/spare parts

Selection and ordering data

Size	Rated current I_n	3-pole			4-pole		
		Article No.	Price	Weight approx. kg	Article No.	Price	Weight approx. kg
Guide frame for withdrawable version, horizontal main circuit connection, 2 auxiliary supply connectors							
I	400 ... 1250 N, S class.; 1600 N class	3WT9883-2AC10		22.000	3WT9883-2AC30		27.000
I	1600 S class	3WT9883-4AC10		23.000	3WT9883-4AC30		28.000
II	630 ... 2500	3WT9883-6AC10		37.000	3WT9883-6AC30		48.000
II	3200	3WT9883-7AC10		37.000	3WT9883-7AC30		48.000
Guide frame for withdrawable version, horizontal main circuit connection at top, vertical connection at bottom, 2 auxiliary supply connectors							
I	400 ... 1250 N, S class.; 1600 N class	3WT9883-2BC10		22.000	3WT9883-2BC30		27.000
I	1600 S class	3WT9883-4BC10		23.000	3WT9883-4BC30		28.000
II	630 ... 2500	3WT9883-6BC10		37.000	3WT9883-6BC30		48.000
II	3200	3WT9883-7BC10		37.000	3WT9883-7BC30		48.000
Guide frame for withdrawable version, vertical main circuit connection at top and bottom, 2 auxiliary supply connectors							
I	400 ... 1250 N, S class.; 1600 N class	3WT9883-2BC20		22.000	3WT9883-2BC40		27.000
I	1600 S class	3WT9883-4BC20		23.000	3WT9883-4BC40		28.000
II	630 ... 2500	3WT9883-6BC20		37.000	3WT9883-6BC40		48.000
II	3200	3WT9883-7BC20		37.000	3WT9883-7BC40		48.000
II	3800	3WT9883-8BC20		37.000	3WT9883-8BC40		48.000

For fixed-mounted and withdrawable circuit breakers

Current transformers for neutral conductor overload protection and ground-fault protection

Only one of the two measuring methods is permissible in conjunction with the electronic trip unit. The overload protection for the neutral conductor takes effect when the current transformer is fitted in the neutral conductor. The ground-fault current is calculated by means of summation current formation of the phases and the neutral conductor.

Type of detection (see page 2/7) Designation	Frame size of the circuit breaker	Required order quantity per circuit breaker	For 1 set or 1 unit Article No.	Price	Weight approx. kg
Vectorial summation with current transformer in the neutral conductor					
Current transformers for 3-pole circuit breakers, external neutral conductor with copper busbars	I	1 unit	3WL9111-0AA31-0AA0		1.600
	II	1 unit	3WL9111-0AA32-0AA0		4.260
Current transformers for 3-pole circuit breakers, external neutral conductor without copper busbars	I	1 unit	3WL9111-0AA21-0AA0		0.321
	II	1 unit	3WL9111-0AA22-0AA0		0.490
Designation	Rated control supply voltage/ rated operational voltage	Order quantity	For 1 set or 1 unit		
	AC 50/60 Hz				

Commissioning and service tools					
Manual function tester for electronic trip unit for versions ETU35WT ... ETU47WT	110 ... 127/220 ... 240 V	1 unit	3WL9111-0AT32-0AA0		1.810
For fixed-mounted circuit breakers					
Door sealing frame IP41		1 unit	3WT9886-0JA00		1.000
Protective covers, IP55 Cannot be used in conjunction with door sealing frames, cover removable and can be opened on both sides		1 unit	3WL9111-0AP02-0AA0		2.400

When retrofitting, the circuit breaker Article No. must be added to the name plate on the operator panel and to the side wall of the circuit breaker in accordance with the installation instructions.

Designation	Required order quantity per circuit breaker	For 1 set or 1 unit Article No.	Price	Weight approx. kg
For fixed-mounted and withdrawable circuit breakers				
5-digit operating cycles counter	1 unit	3WT9864-0CA00		0.500
Auxiliary release	Rated control supply voltage			
	AC 50/60 Hz V	DC V		
Shunt release "f" for 1st and 2nd auxiliary release (F1 and F2) and closing solenoid (Y1)	--	24	1 unit	3WT9851-1JB00 0.800
	110 ... 127	110 ... 125	1 unit	3WT9851-1JH00 0.800
	220 ... 240	220 ... 250	1 unit	3WT9851-1JK00 0.800
Undervoltage release "r" (F3) instantaneous 0 ms, short-delay 200 ms	--	24	1 unit	3WT9853-1JB00 0.800
	110 ... 127	110 ... 125	1 unit	3WT9853-1JH00 0.800
	220 ... 240	220 ... 250	1 unit	3WT9853-1JK00 0.800
	380 ... 415	--	1 unit	3WT9853-1JM00 0.800
Undervoltage release "rc" (F8) can be delayed 0.2 ... 3.2 s	110 ... 127	110 ... 125	1 unit	3WT9854-1JH00 0.850
	220 ... 240	220 ... 250	1 unit	3WT9854-1JK00 0.850
	380 ... 415	--	1 unit	3WT9854-1JM00 0.850
Undervoltage release "rc" (F8) can be delayed 0.2 ... 3.2 s for ETU45/47WT release 2 NEW	110 ... 127	110 ... 125	1 unit	3WT9855-1JH00 0.843
	220 ... 240	220 ... 250	1 unit	3WT9855-1JK00 0.825
	380 ... 415	--	1 unit	3WT9855-1JM00 0.772
Auxiliary switches	2nd auxiliary contact block in addition to the 1st auxiliary contact block			
2 CO			1 unit	3WT9816-1CE00 0.070
2 CO for ETU45/47WT release 2 NEW			1 unit	3WT9888-1CH00 0.068
2 NC and 2 NO			1 unit	3WT9816-1CD00 0.180
3 NO and 1 NC			1 unit	3WT9816-1CF00 0.170
4 NO			1 unit	3WT9816-1CG00 0.170
Motorized operating mechanism and electrical closing (possible if 9th position of Article No. for circuit breaker is "A")	Consisting of motor and closing solenoid (Y1) Rated control supply voltage			
	Motor		Closing solenoid	
	AC 50/60 Hz V	DC V	AC 50/60 Hz V	DC V
	110 ... 127	110 ... 125	110 ... 127	110 ... 125
	220 ... 240	220 ... 250	220 ... 240	220 ... 250
			1 unit	3WT9831-1JH00 2.400
			1 unit	3WT9831-1JK00 2.400
Motorized operating mechanism	Consisting of motor and wiring Rated control supply voltage of motor			
	AC 50/60 Hz V	DC V		
	--	24	1 unit	3WT9832-1JB00 1.600
	110 ... 127	110 ... 125	1 unit	3WT9832-1JH00 1.600
	220 ... 240	220 ... 250	1 unit	3WT9832-1JK00 1.686
Electrical closing (possible if 9th position of Article No. for circuit breaker is "A")	Consisting of closing solenoid (Y1), electrical ON button and wiring Rated control supply voltage of closing solenoid (Y1)			
	AC 50/60 Hz V	DC V		
	--	24	1 unit	3WT9833-1JB00 0.800
	110 ... 127	110 ... 125	1 unit	3WT9833-1JH00 0.800
	220 ... 240	220 ... 250	1 unit	3WT9833-1JK00 0.800
Mutual mechanical interlock for 3WT circuit breaker	An interlock module with a Bowden wire (2 m) for one fixed-mounted circuit breaker		1 unit	3WT9866-3JA00 3.000
	for one withdrawable circuit breaker		1 unit	3WT9866-4JA00 1.000
	Interlocking of three circuit breakers additional Bowden wire required for each circuit breaker			
	Bowden wire (2 m)		1 unit	3WT9866-8JA00 0.200
	Bowden wire (3 m)		1 unit	3WT9866-8JA01 0.500
	Bowden wire (4.5 m)		1 unit	3WT9866-8JA02 2.500
Interlocking systems	• 3WT locks • 2 of the same keys for 3 circuit breakers • Locking device in OFF position • Lock in the operator panel • A maximum of 2 circuit breakers can be switched on • Preparation for CASTELL lock is necessary ⁴⁾		1 unit	3WT9863-7JE00 0.360
Locking device consisting of safety locks or padlocks to prevent unauthorized closing of the circuit breaker	Safety lock (3SB1) instead of the OFF button		Made by CES Normal lock no. SSG 10	1 unit
	Mounting set ¹⁾ for 3WT lock ³⁾ , CASTELL or FORTRESS lock ²⁾		1 unit	3WT9863-6JE00 0.100
	Interlock to be obtained from the lock manufacturer CASTELL lock (FS 2) or FORTRESS lock (H31LH/65°/standard)			

00035



¹⁾ The 3WT9863-6JE locking system meets the isolation conditions to IEC 60947-1 and IEC 60947-1/A1.

²⁾ Locks are available at the manufacturer of the locks.

³⁾ Interlock system 2 identical keys for 3 circuit breakers 3WT9863-7JE00.

⁴⁾ Directly in the circuit breaker order or as an accessory 3WT9863-6JE00.

3WT Air Circuit Breakers up to 4000 A (AC)

Accessories/spare parts

When retrofitting, the circuit breaker Article No. must be added to the name plate on the operator panel and to the side wall of the circuit breaker in accordance with the installation instructions.

Designation/ for circuit breaker Type	Rated current I_n	Size	Number of poles	Required order quan- tity per cir- cuit breaker	For 1 set or 1 unit Article No.	Price	Weight approx. kg	
For fixed-mounted and withdrawable circuit breakers								
Crank handle								
For withdrawable circuit breaker				1 unit	3WT9884-0JA00		0.500	
Electronic trip unit								
ETU35WT, LSI with display				1 unit	3WT9841-4AA00		1.200	
ETU37WT, LSING with display				1 unit	3WT9841-5AB00		1.000	
ETU45WT, LSIN with display				1 unit	3WT9841-6AC00		1.200	
ETU47WT, LSING with display				1 unit	3WT9841-7AD00		1.200	
ETU45WT, LSIN with display, release 2 with communication capability				1 unit	3WT9841-6AC02		0.316	
ETU47WT, LSING with display, release 2 with communication capability				1 unit	3WT9841-7AD02		0.314	
ETU45WT, LSIN with display, release 2 with communication capability and metering				1 unit	3WT9841-6AC22		0.403	
ETU47WT, LSING with display, release 2 with communication capability and metering				1 unit	3WT9841-7AD22		0.404	
Phase barrier								
For fixed-mounted circuit breaker		I	3-pole	1 unit	3WT9831-0AA00		0.950	
			4-pole	1 unit	3WT9831-0AC00		1.130	
		II	3-pole	1 unit	3WT9831-0AE00		0.900	
			4-pole	1 unit	3WT9831-0AG00		1.050	
For withdrawable circuit breaker		I	3-pole	1 unit	3WT9831-0AB00		1.250	
			4-pole	1 unit	3WT9831-0AD00		1.500	
		II	3-pole	1 unit	3WT9831-0AF00		1.050	
			4-pole	1 unit	3WT9831-0AJ00		1.280	
Communication and meterings								
Breaker status sensor (BSSWT) , for ETU45/47WT release 2				1 unit	3WT9844-0AT00		0.053	
Communication module COM16WT MODBUS RTU, for ETU45/47WT release 2				1 unit	3WT9844-1AT00		0.146	
Internal voltage converter, for ETU45/47WT release 2				1 unit	3WT9844-4AT00		0.061	
Metering module, for ETU45/47WT release 2				1 unit	3WT9844-5AT00		0.095	
Mounting adapter for COM16WT fix-mounted				1 unit	3WT9844-2AT00		0.202	
Mounting adapter for COM16WT draw-out				1 unit	3WT9844-3AT00		0.196	
For fixed-mounted circuit breakers								
Connecting bars								
for vertical connection	up to 1250 A up to 1250 A N, I S class; 1600 A, N class	I	3- and 4-pole	1 unit ³⁾	3WT9821-7AC00		2.000	
			I	3- and 4-pole	1 unit ³⁾	3WT9821-7BC00		4.100
				3-pole	1 set ¹⁾	3WT9821-7DA00		5.500
			II	4-pole	1 set ²⁾	3WT9821-7DB00		7.400
				3-pole	1 set ¹⁾	3WT9821-7FA00		4.800
3200 A	II	4-pole	1 set ²⁾	3WT9821-7FB00		6.500		
Connecting bars for front-accessible connection Vertical double-hole bar (holes to DIN 43673)	up to 1250 A up to 1250 A N, I S class; 1600 A, N class	I	3- and 4-pole	1 unit ³⁾	3WT9821-1AA01		0.980	
			I	3- and 4-pole	1 unit ³⁾	3WT9821-1BA01		2.060
				3- and 4-pole	1 unit ³⁾	3WT9821-1DA01		2.530
			3200 A	II	3- and 4-pole	1 unit ³⁾	3WT9821-1FA01	
Auxiliary supply connectors				1 unit	3WT9825-1JC00		0.080	
Blocking device to prevent opening of the cabinet door with the fixed-mounted circuit breaker closed				1 unit	3WT9867-2JA00		0.700	
Conversion set from fixed-mounted to withdrawable version = single operating mechanism	up to 1600 A	I	3-pole	1 unit	3WT9888-0GA00		3.500	
			4-pole	1 unit	3WT9888-0HA00		3.500	
	up to 3200 A	II	3-pole	1 unit	3WT9888-0KA00		5.000	
			4-pole	1 unit	3WT9888-0LA00		4.200	
For guide frames								
Connecting bar for addi- tional terminal acces- sible from the front Vertical double-hole bar (holes to DIN 43673)	up to 1250 A up to 1250 A N, I S class; 1600 A N class	I	3- and 4-pole	1 unit ³⁾	3WT9823-1AA01		1.300	
			I	3- and 4-pole	1 unit ³⁾	3WT9823-1BA01		1.800
				3- and 4-pole	1 unit ³⁾	3WT9823-1DA01		2.530
			3200 A	II	3- and 4-pole	1 unit ³⁾	3WT9823-1EA01	

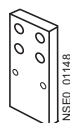
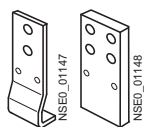

1) 1 set = 3 units.

2) 1 set = 4 units.

3) Please order the number of connecting bars as required for the application.

When retrofitting, the circuit breaker Article No. must be added to the name plate on the operator panel and to the side wall of the circuit breaker in accordance with the installation instructions.

Designation/ for circuit breaker Type	Rated current I_n	Size	Numbers of poles	Required order quantity per circuit breaker	For 1 set or 1 unit		Weight approx. kg
					Article No.	Price	
For guide frames							
Connecting bar for rear vertical connection	up to 1250 A up to 1250 A I N, S class; 1600 A N class	I	3- and 4-pole	1 unit ³⁾		3WT9823-3AA00	1.500
	1600 A S class	I	3- and 4-pole	1 unit ³⁾		3WT9823-3BA00	1.500
	630 A and 2500 A	II	3-pole	1 set ¹⁾		3WT9823-4AB00	2.600
			4-pole	1 set ²⁾		3WT9823-4AC00	3.500
3200 A	II	3-pole	1 set ¹⁾		3WT9823-4BB00	5.400	
			4-pole	1 set ²⁾		3WT9823-4BC00	7.100
Position indicator switch (actuated by withdraw- able circuit breaker)	Connected position	Test position	Disconnec- ted position	Precondition	1 unit	3WT9884-1JC10	0.280
	3 NO + 3 NC	2 NO + 2 NC	1 NO + 1 NC	possible if no pos. switch mounted yet			
Automatic mechanical resetting device after overcurrent tripping				1 unit		3WT9866-2JA00	0.050
Shutters Protection against touching the main contacts	1600 A	I	3-pole	1 unit		3WT9884-3CA00	0.500
	630 A ... 3800 A	II	4-pole	1 unit		3WT9884-3DA00	0.630
	1600 A	I	4-pole	1 unit		3WT9884-3CB00	0.500
	630 A ... 3800 A	II	4-pole	1 unit		3WT9884-3DB00	0.500
Auxiliary supply connectors	up to 4000 A	I, II	3- and 4-pole	1 unit		3WT9827-1JA00	0.160
For guide frames – for spare parts and retrofitting							
Arc chute cover		I	3-pole	1 unit		3WT9811-0GA00	3.820
			4-pole	1 unit		3WT9811-0HA00	4.950
		II	3-pole	1 unit		3WT9811-0JA00	4.900
			4-pole	1 unit		3WT9811-0KA00	5.600
For withdrawable circuit breakers							
Blocking device to prevent opening of the cabinet door, when circuit breaker is in connected position	up to 4000 A	I, II	3- and 4-pole	1 unit		3WT9867-1JC00	0.100
For fixed-mounted and withdrawable circuit breakers							
Main contact	up to 1250 A, N class, breaking capacity N	I	3-pole	1 unit		3WT9821-0AA00	2.000
			4-pole	1 unit		3WT9821-0AA00	2.000
			3-pole	1 unit		3WT9821-0AA10	2.500
			4-pole	1 unit		3WT9821-0AA10	2.500
	up to 1600 A, S class $I_{cw} = 50$ kA	I	3-pole	1 unit		3WT9821-0BA00	3.000
			4-pole	1 unit		3WT9821-0BA00	3.000
	up to 2500 A	II	3-pole	1 unit		3WT9821-0DA00	5.300
			4-pole	1 unit		3WT9821-0DA00	5.300
for fixed-mounted circuit breakers only	up to 4000 A	II	3-pole	1 unit		3WT9821-0FA00	7.300
			4-pole	1 unit		3WT9821-0FA00	7.300
for withdrawable circuit breakers and for fixed-mounted circuit breakers	up to 3200 A	II	3-pole	1 unit		3WT9821-0FA00	7.300
	4000 A		4-pole	1 unit		3WT9821-0FA00	7.300
for withdrawable circuit breakers only	3800 A	II	3-pole	1 unit		3WT9821-0GA00	7.300
			4-pole	1 unit		3WT9821-0GA00	7.300
Arc chute	up to 1600 A	I	3-pole	1 unit		3WT9811-0CA00	1.800
			4-pole	1 unit		3WT9811-0CA00	1.800
	630 A ... 4000 A	II	3-pole	1 unit		3WT9811-0FA00	2.500
			4-pole	1 unit		3WT9811-0FA00	2.500
Installation manual for 3WT8⁴⁾							
Chinese language						3ZX1812-0WT81-0AN0	1.000
English language						3ZX1812-0WT82-0AN0	1.000

1) 1 set = 3 units.

2) 1 set = 4 units.

3) Please order the number of connecting bars as required for the application.

4) More languages are available as PDF online.

3WT Air Circuit Breakers up to 4000 A (AC)

Project planning aids

Characteristic curves²⁾

Every electronic trip unit type and every setting has its own characteristic. Only a selection is shown in the following. The characteristic curves each show the largest and smallest setting range of 3WT8 circuit breakers with 1000 A rated current at 500 V rated voltage with various trip units.

In order to obtain a complete tripping characteristic, the relevant parts of the characteristic have to be combined.

The characteristic curves show the behavior of the electronic trip unit when it is activated by a current that is already flowing before the tripping operation. If the overcurrent tripping occurs im-

mediately after switch on and the electronic trip unit is therefore not yet enabled, the opening time is extended, depending on the level of the overcurrent by up to 15 ms. In order to determine the break-times of the circuit breakers, approximately 15 ms must be added to the opening times shown for the arcing time.

Refer to the following legend for tolerances.

The characteristic curves shown apply to ambient temperatures at the circuit breaker between -5 and +55 °C. The trip unit can be operated at ambient temperatures of -20 to +70 °C. An extended tolerance band can apply at these temperatures.

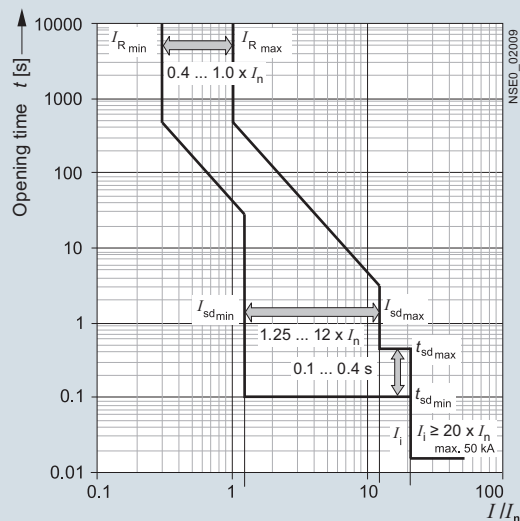

3WT8 circuit breaker with ETU35WT electronic trip unit, LSI characteristic curve

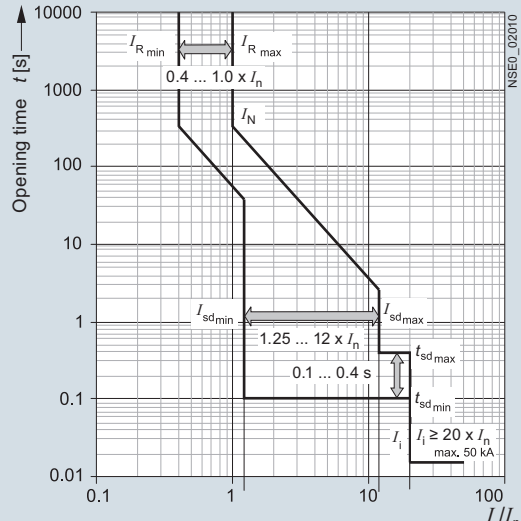

3WT8 circuit breaker with ETU37WT electronic trip unit, LSIN characteristic curve

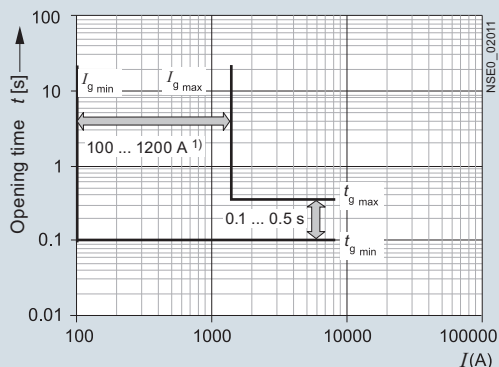

3WT8 circuit breaker with ETU37WT electronic trip unit, G characteristic curve³⁾

Tolerances for the set currents

L: Tripping operations between 1.05 and 1.2 x I_R

S: -0 %, +20 %

I: -0 %, +20 %

G: -0 %, +20 %

Tolerances for the tripping times

L: -20 %, +0 % for I^2t characteristic curve

S: -0 %, +60 ms or -0 %, 10 % for characteristic curve with fixed delay time

I: <50 ms

G: -0 %, +60 ms or -0 %, 10 % for characteristic curve with fixed delay time

¹⁾ Sizes I and II: 100 ... 1200 A.

²⁾ With single-pole loading in the lowest rated current range, the response times of the short-circuit release can be extended by approx. 10 % and the tripping times by approx. 15 % compared to the characteristic curve.

³⁾ As a result of the activation level of 150 A (frame size I) and 200 A (frame size II) in case of a single-pole loading the minimum pick-up value of ground fault will be $I_g = 300$ A.

Every electronic trip unit type and every setting has its own characteristic. Only a selection is shown in the following. The characteristic curves each show the largest and smallest setting range of 3WT8 circuit breakers with 1000 A rated current at 500 V rated voltage with various trip units.

In order to obtain a complete tripping characteristic, the relevant parts of the characteristic have to be combined.

The characteristic curves show the behavior of the electronic trip unit when it is activated by a current that is already flowing before the tripping operation. If the overcurrent tripping occurs im-

mediately after switch on and the electronic trip unit is therefore not yet enabled, the opening time is extended, depending on the level of the overcurrent by up to 15 ms. In order to determine the break-times of the circuit breakers, approximately 15 ms must be added to the opening times shown for the arcing time.

Refer to the following legend for tolerances.

The characteristic curves shown apply to ambient temperatures at the circuit breaker between -5 and +55 °C. The trip unit can be operated at ambient temperatures of -20 to +70 °C. An extended tolerance band can apply at these temperatures.

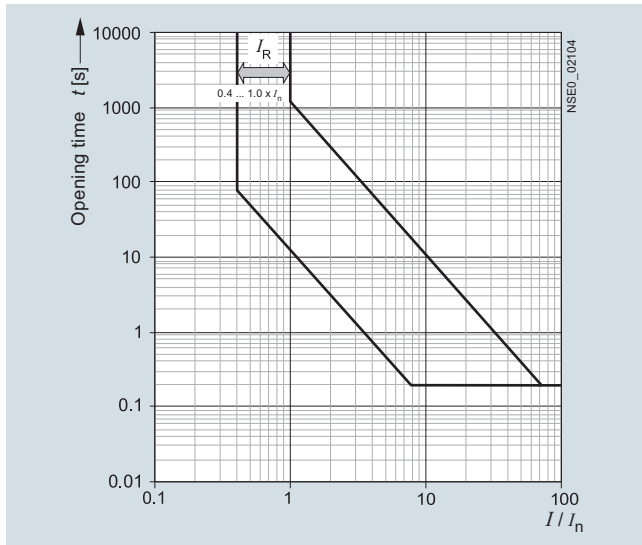

3WT8 circuit breaker with ETU45WT and ETU47WT electronic trip unit, L characteristic curve

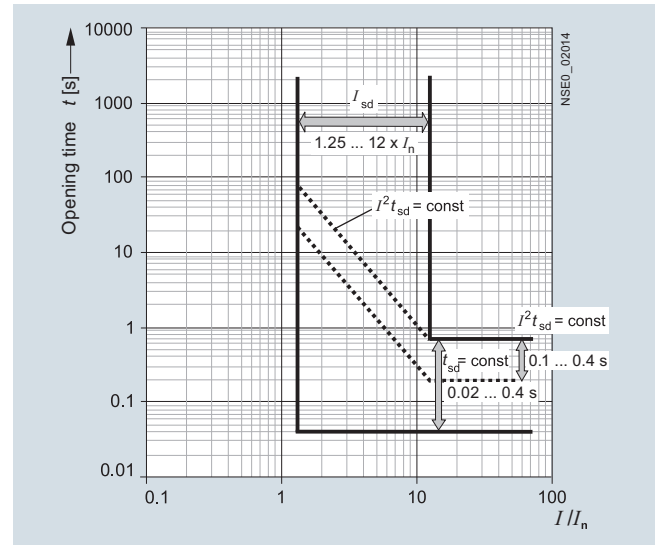

3WT8 circuit breaker with ETU45WT and ETU47WT electronic trip unit, S characteristic curve

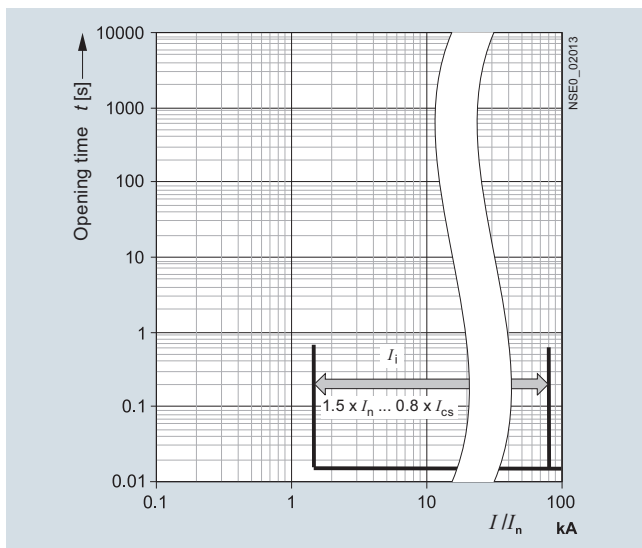

3WT8 circuit breaker with ETU45WT and ETU47WT electronic trip unit, I characteristic curve

Tolerances for the set currents

L: Tripping operations between 1.05 and 1.2 x I_R

S: -0 %, +20 %

I: -0 %, +20 %

G: -0 %, +20 %

Tolerances for the tripping times

L: -20 %, +0 % for $I^2 t$ characteristic curve

S: -0 %, +60 ms or -0 %, 10 % for characteristic curve with fixed delay time

I: <50 ms

G: -0 %, +60 ms or -0 %, 10 % for characteristic curve with fixed delay time

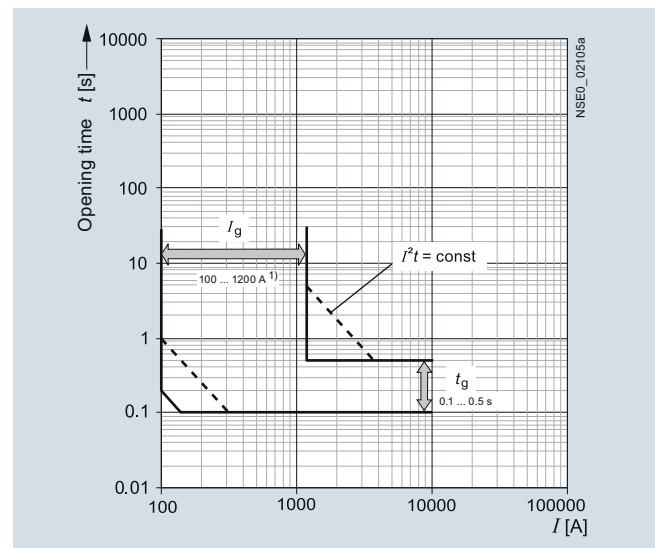

3WT8 circuit breaker with ETU47WT electronic trip unit, G characteristic curve²⁾

¹⁾ Sizes I and II: 100 ... 1200 A.

²⁾ As a result of the activation level of 150 A (frame size I) and 200 A (frame size II) in case of a single-pole loading the minimum pick-up value of ground fault will be $I_g = 300$ A.

3WT Air Circuit Breakers up to 4000 A (AC)

Project planning aids

Dimensional drawings

3WT circuit breakers, withdrawable version, 3-pole

Horizontal connection

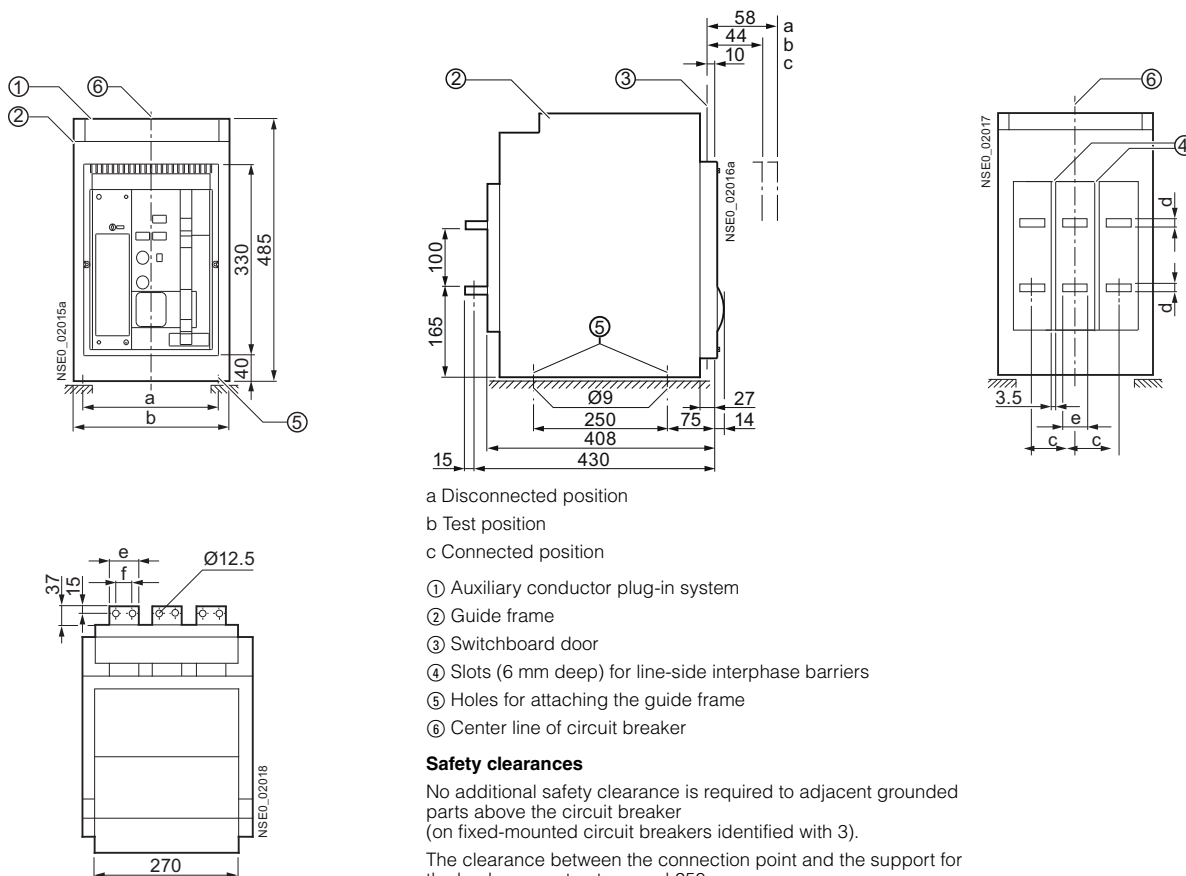

Safety clearances

No additional safety clearance is required to adjacent grounded parts above the circuit breaker (on fixed-mounted circuit breakers identified with 3).

The clearance between the connection point and the support for the busbars must not exceed 250 mm.

All dimensions in mm.

Frame size	Rated current A	a	b	c	d	e	f
I	≤ 1250 A, N, S	280	320	90	8	60	30
	1600 A, N	280	320	90	8	60	30
	1600 A, S	280	320	90	15	60	30
II	630 to 2500	380	420	120	15	80	40
	3200	380	420	120	30	100	50

Main conductor connection

Terminal screws with strain washers (inside diameter = 12 mm to DIN 6769-Fst)	M12
Recommended tightening torque	Nm 70
Required strength of screws	8.8 to DIN 267

Up to a rated operating voltage of AC 500 V the busbars running vertically (such as in the case of front-accessible connection) do not have to be screened if the busbar system is not arranged above the circuit breaker. In contrast, live bare conductors and busbars at voltages above AC 500 V that are arranged above the circuit breaker and when power is supplied from above must be insulated against flashover by interphase barriers or by a busbar cover or by an arc chute cover (use accessory for horizontal or vertical connection only).

Optional electrical equipment directly above (if no arc chute cover is used) or to the side of the circuit breaker should be protected by a cover. Also after the attachment of additional barriers or covers it must be ensured that the dissipation of heat from the circuit breaker is not impeded.

3WT circuit breakers, withdrawable version, 3-pole

Front connection

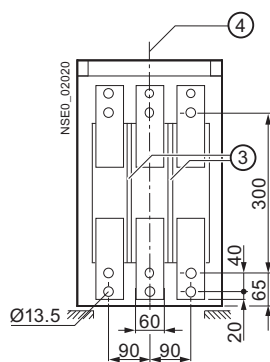
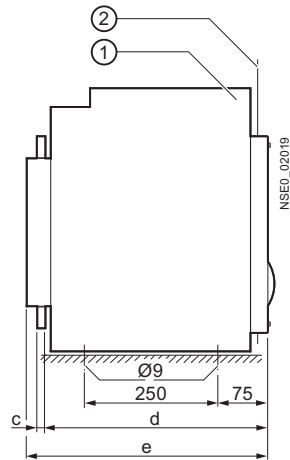

Double hole, 400 to 1600 A
Holes in bars to DIN 43673

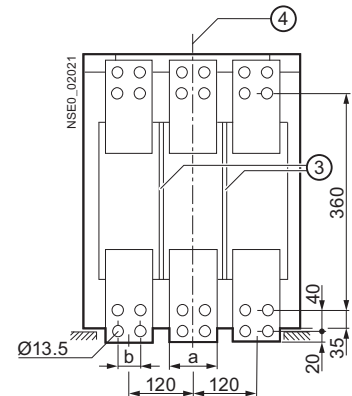

Double hole, 2000 to 3200 A
Holes in bars to DIN 43673

Frame size	Rated current A	a	b	c	d	e
I	≤ 1250 A, N, S	60	--	8	390	408
	1600 A, N	60	--	8	390	408
	1600 A, S	60	--	15	390	408
II	630 to 2500	80	40	20	420	445
	3200	100	50	20	420	445

Vertical connection up to 3200 A

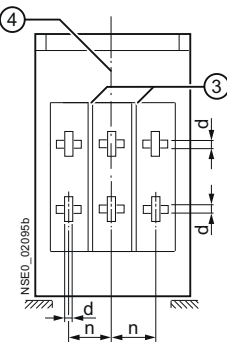
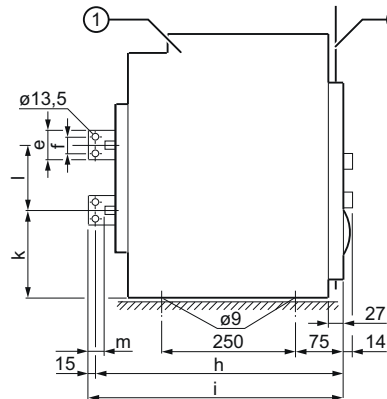

- ① Guide frame
- ② Switchboard door
- ③ Slots (6 mm deep, 3.5 mm wide) for line-side phase barriers
- ④ Center line of circuit breaker

For safety clearances see page 2/38.
All dimensions in mm.

Frame size	Rated current A	a	b	c	d	e	f	h	i	k	l	m	n
I	≤ 1250 A, N, S	280	320	90	8	60	30	455	470	157.5	115	37	90
	1600 A, N	280	320	90	8	60	30	455	470	157.5	115	37	90
	1600 A, S	280	320	90	15	60	30	455	470	157.5	115	37	90
II	630 to 2500	380	420	120	15	80	40	465	480	157.5	115	37	140
	3200	380	420	120	30	100	50	465	480	150	130	37	140

Vertical connection 3800 A only - other mounting dimensions are equivalent to 3200 A version.

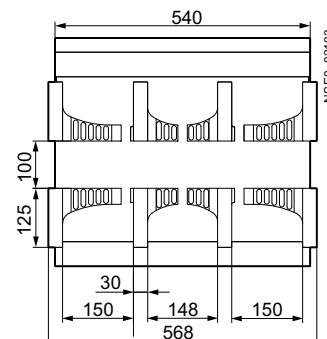
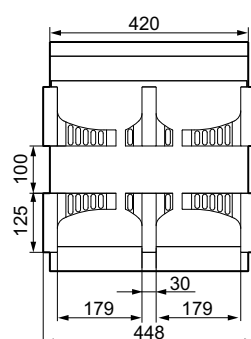
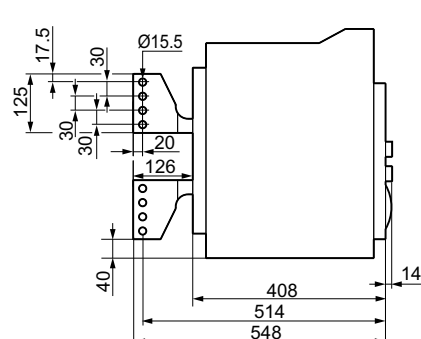

3WT Air Circuit Breakers up to 4000 A (AC)

Project planning aids

3WT fixed-mounted circuit breakers, 3-pole

Horizontal connection

2

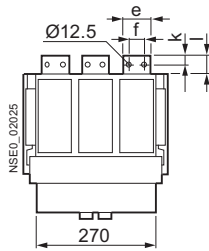
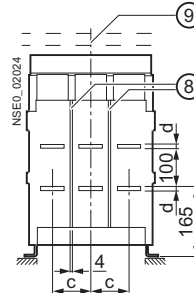
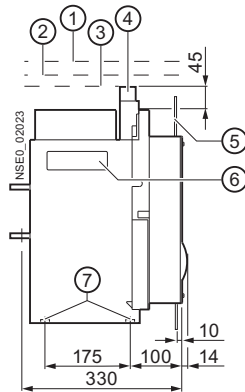
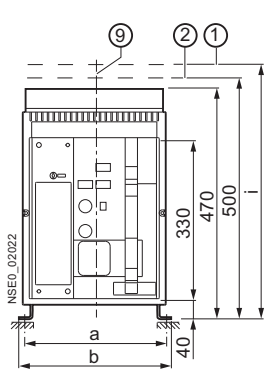

- ① Clearance for lifting out the arc chute
- ② Space for auxiliary supply connectors
- ③ Space above arc chute
- ④ Auxiliary supply connectors
- ⑤ Switchboard door
- ⑥ Recessed grip
- ⑦ M8 nut
- ⑧ Slots (4 mm deep) for line-side phase barriers
- ⑨ Center line of circuit breaker

For safety clearances see page 2/38.
All dimensions in mm.

Front connection

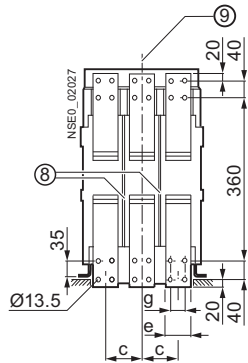
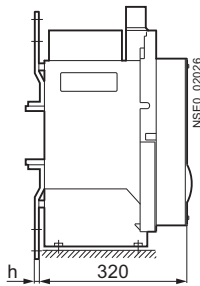

Double hole
Holes in bars to DIN 43673

Frame size	Rated current A	a	b	c	d	e	f	g	h	i	k	l
I	≤ 1250 A, N, S	300	320	90	8	60	30	--	8	530	18	40
	1600 A, N	300	320	90	8	60	30	--	8	530	18	40
	1600 A, S	300	320	90	15	60	30	--	20	530	18	40
II	630 to 2500	400	420	120	15	80	40	40	20	560	22	44
	3200	400	420	120	30	80	40	40	20	560	22	44

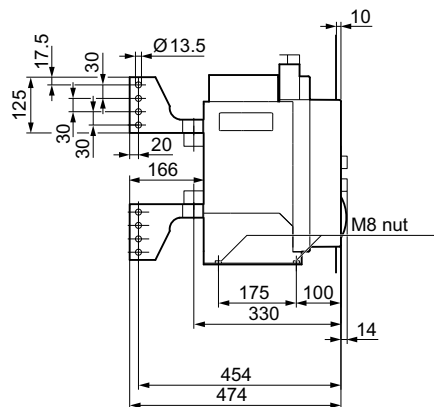
3WT fixed-mounted circuit breakers, 3-pole and 4 pole**Vertical connection 4000 A only**

All dimensions in mm.

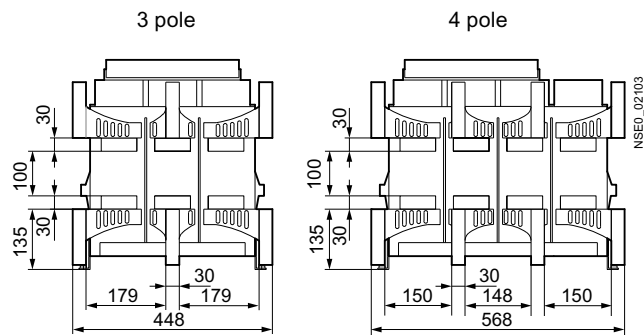

3WT Air Circuit Breakers up to 4000 A (AC)

Project planning aids

3WT circuit breakers, withdrawable version, 4-pole

Horizontal connection

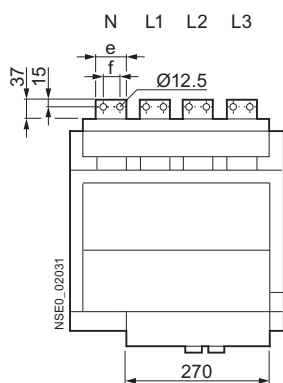
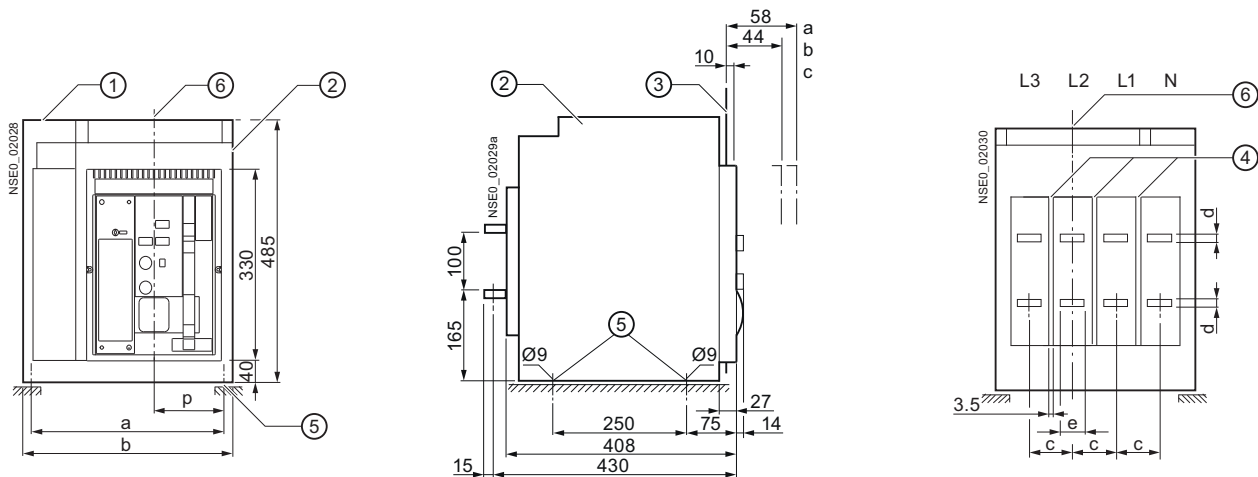

a Disconnected position

b Test position

c Connected position

① Auxiliary conductor plug-in system

② Guide frame

③ Switchboard door

④ Slots (6 mm deep) for line-side phase barriers

⑤ Holes for attaching the guide frame

⑥ Center line of operator panel

For safety clearances see page 2/38.

All dimensions in mm.

Frame size	Rated current A	a	b	c	d	e	f	p
I	≤ 1250 A, N, S	370	410	90	8	60	30	140
	1600 A, N	370	410	90	8	60	30	140
	1600 A, S	370	410	90	15	60	30	140
II	630 to 2500	500	540	120	15	80	40	190
	3200	500	540	120	30	100	50	190

3WT circuit breakers, withdrawable version, 4-pole

Front connection

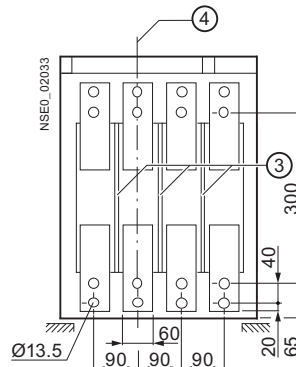
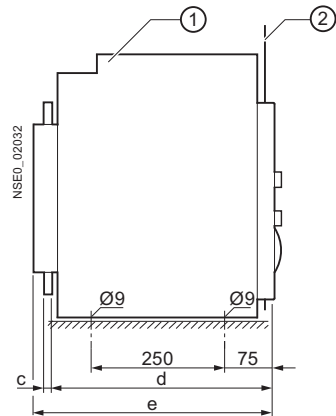

Double hole, 400 to 1600 A
Holes in bars to DIN 43673

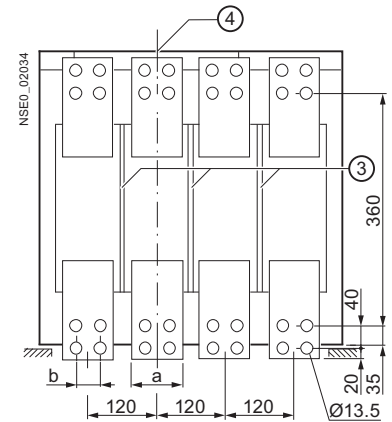

Double hole, 2000 to 3200 A
Holes in bars to DIN 43673

Frame size	Rated current A	a	b	c	d	e
I	≤ 1250 A, N, S	60	--	8	390	408
	1600 A, N	60	--	8	390	408
	1600 A, S	60	--	15	390	408
II	630 to 2500	80	40	20	420	445
	3200	100	50	20	420	445

Vertical connection up to 3200 A

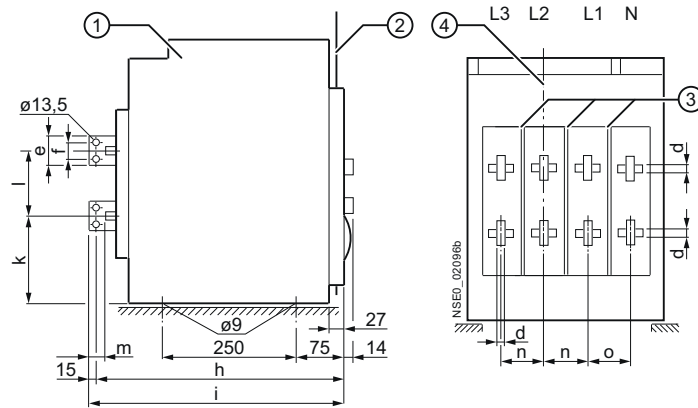

- ① Guide frame
- ② Switchboard door
- ③ Slots (6 mm deep, 3.5 mm wide) for line-side phase barriers
- ④ Center line of operator panel

For safety clearances see page 2/38.
All dimensions in mm.

Frame size	Rated current A	d	e	f	h	i	k	l	m	n	o
I	≤ 1250 A, N, S	8	60	30	455	470	157.5	115	37	90	90
	1600 A, N	8	60	30	455	470	157.5	115	37	90	90
	1600 A, S	15	60	30	455	470	157.5	115	37	90	90
II	630 to 2500	15	80	40	465	480	157.5	115	37	140	120
	3200	30	100	50	465	480	150	130	37	140	120

3WT Air Circuit Breakers up to 4000 A (AC)

Project planning aids

3WT fixed-mounted circuit breakers, 4-pole

Horizontal connection

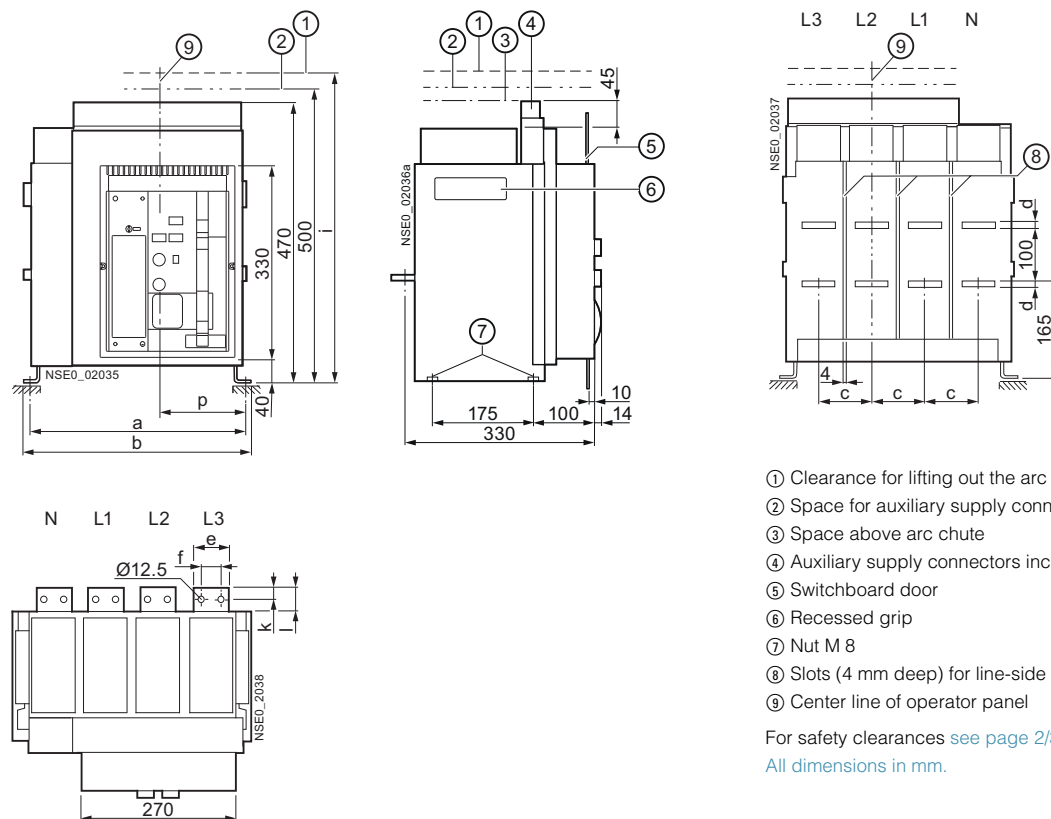

- ① Clearance for lifting out the arc chute
- ② Space for auxiliary supply connectors
- ③ Space above arc chute
- ④ Auxiliary supply connectors incl. wiring space
- ⑤ Switchboard door
- ⑥ Recessed grip
- ⑦ Nut M 8
- ⑧ Slots (4 mm deep) for line-side phase barriers
- ⑨ Center line of operator panel

For safety clearances see page 2/38.

All dimensions in mm.

Front connection

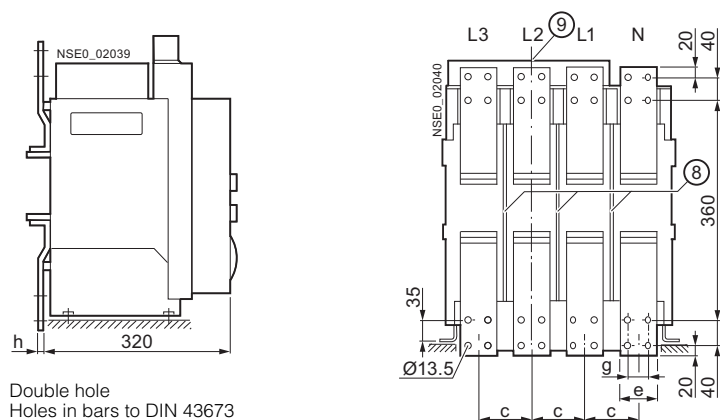

Double hole
Holes in bars to DIN 43673

Frame size	Rated current A	a	b	c	d	e	f	g	h	i	k	l	p
I	≤ 1250 A, N, S	390	410	90	8	60	30	--	8	530	18	40	150
	1600 A, N	390	410	90	8	60	30	--	8	530	18	40	150
	1600 A, S	390	410	90	15	60	30	--	15	530	18	40	150
II	630 to 2500	520	540	120	15	80	40	40	20	560	22	44	200
	3200	520	540	120	30	80	40	40	20	560	22	44	200

3WT circuit breakers, 3- and 4-pole

Arc chute cover

For withdrawable circuit breakers only

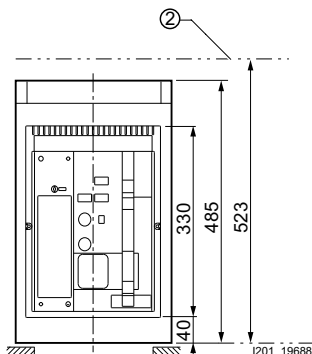

② The dimension of circuit breaker with arc chute cover

All dimensions in mm.

Door cut-out for operator panel using the door sealing frame

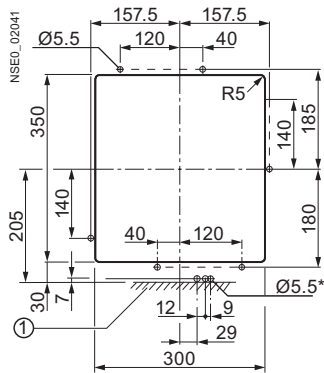

① Mounting surface*3 holes, dia. Ø 5.5 mm; only drill when using door interlocking.

Door cut-out with edge protector

Cut-out after mounting the edge protector

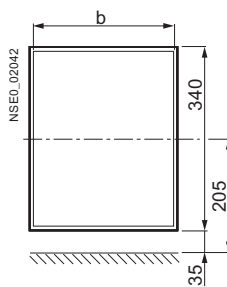

Cut-out when the circuit breaker is installed in a switchgear cabinet and with the door arranged centrally.

Section width	Fixed-mounted b	Withdrawable b
400	275	292
500	275	290
600	275	288

Accessories for 3WT circuit breakers, 3- and 4-pole

Mutual mechanical interlocking (1)/locking device to prevent closing (2), consisting of lock in the control cabinet door and interlock module with Bowden wire

For fixed-mounted circuit breakers

For withdrawable circuit breakers

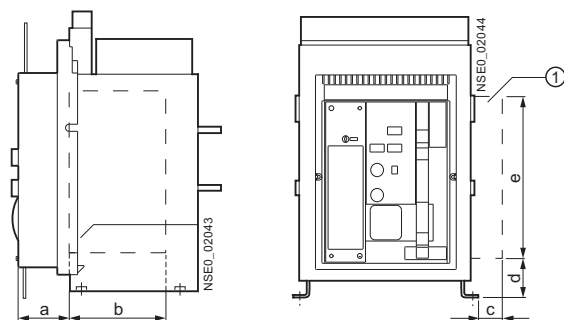

① Clearance for interlock module (without Bowden wire)

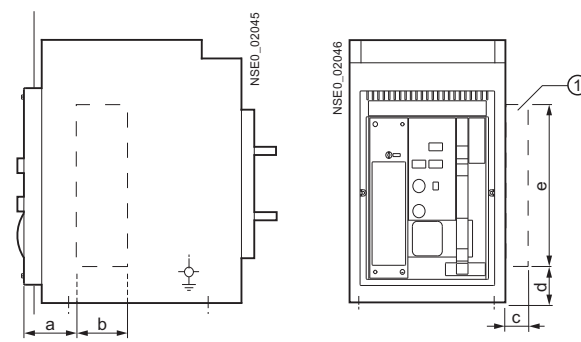

Clearance for	a	b	c	d	e
(1)	90	90	50	65	270
(2)	58	215	10	250	115

All dimensions in mm.

3WT Air Circuit Breakers up to 4000 A (AC)

Project planning aids

Current transformers for overload protection in the neutral conductor

External transformers for neutral conductor with copper busbars

Size I, 3WL9 111-0AA31-0AA0

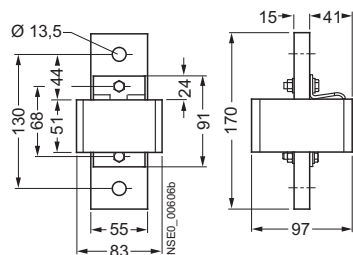

Size II, 3WL9 111-0AA32-0AA0

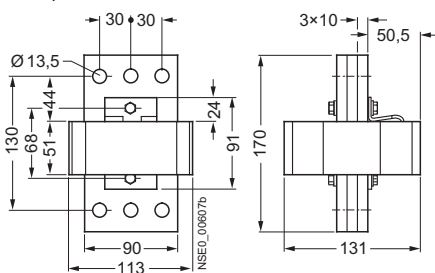

External transformers for neutral conductor without copper busbars

Size I, 3WL9 111-0AA21-0AA0

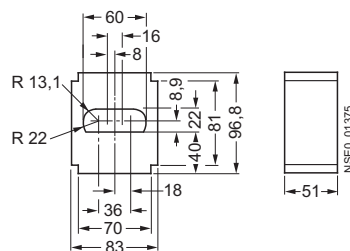

Size II, 3WL9 111-0AA22-0AA0

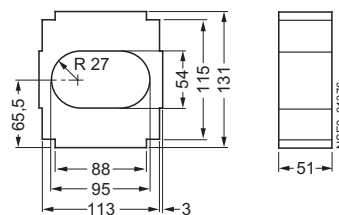

Door cut-out for operator panel using protective cover IP55

Protective cover, IP55

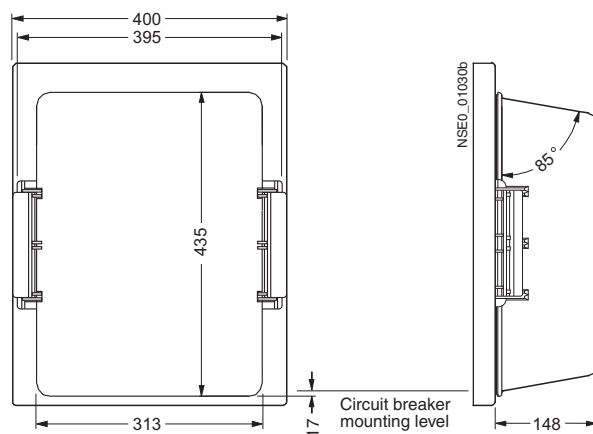
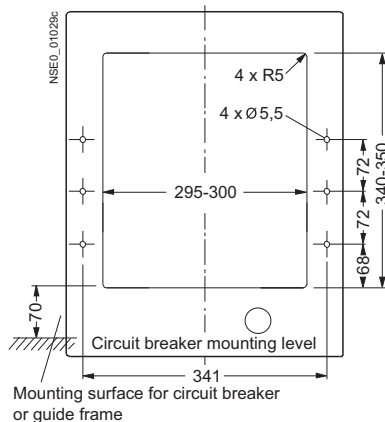

All dimensions in mm.

Schematics

Example of an overall circuit diagram

3WT8 with communication circuit diagram

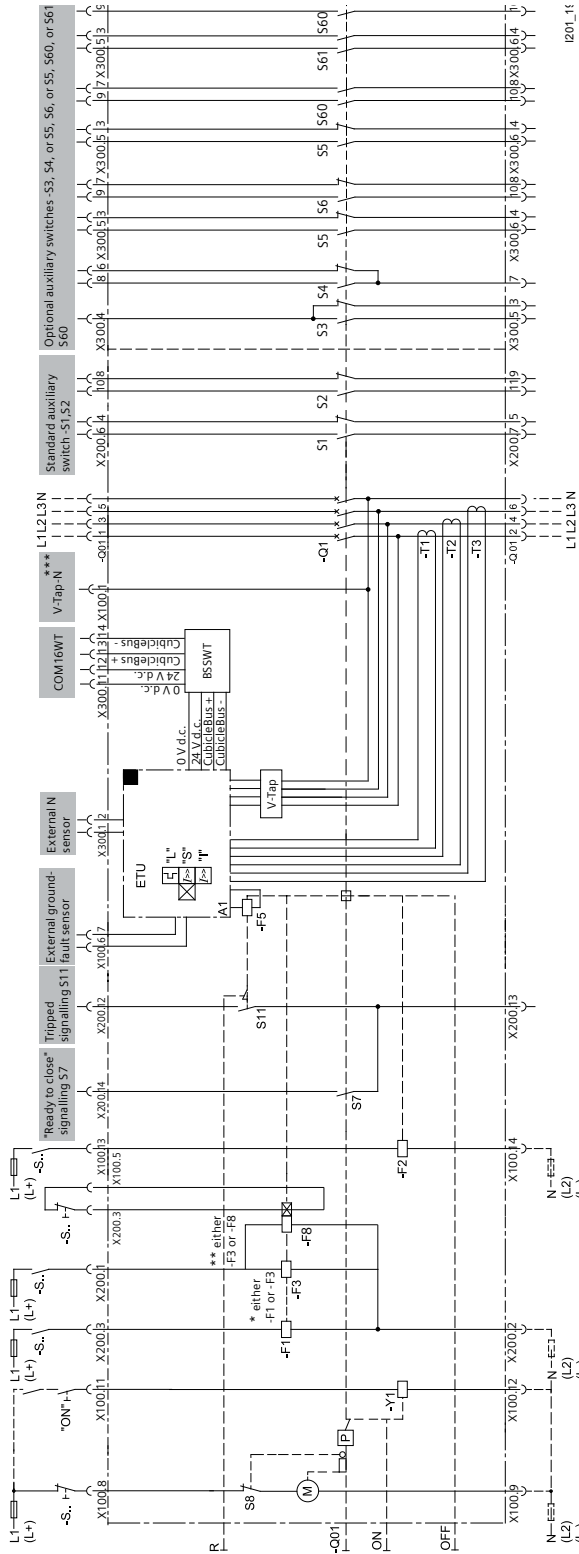

- *) Only one shunt release (F1 or F3) in breaker
- **) Only one shunt release (F3 or F8) in breaker
- ***) Only for 3 pole breaker

3WT Air Circuit Breakers up to 4000 A (AC)

Project planning aids

Terminal diagrams

The following overview shows which part of the internal equipment is connected to which part of the contact blocks, i.e. this is a complete auxiliary wiring diagram of the circuitbreaker.

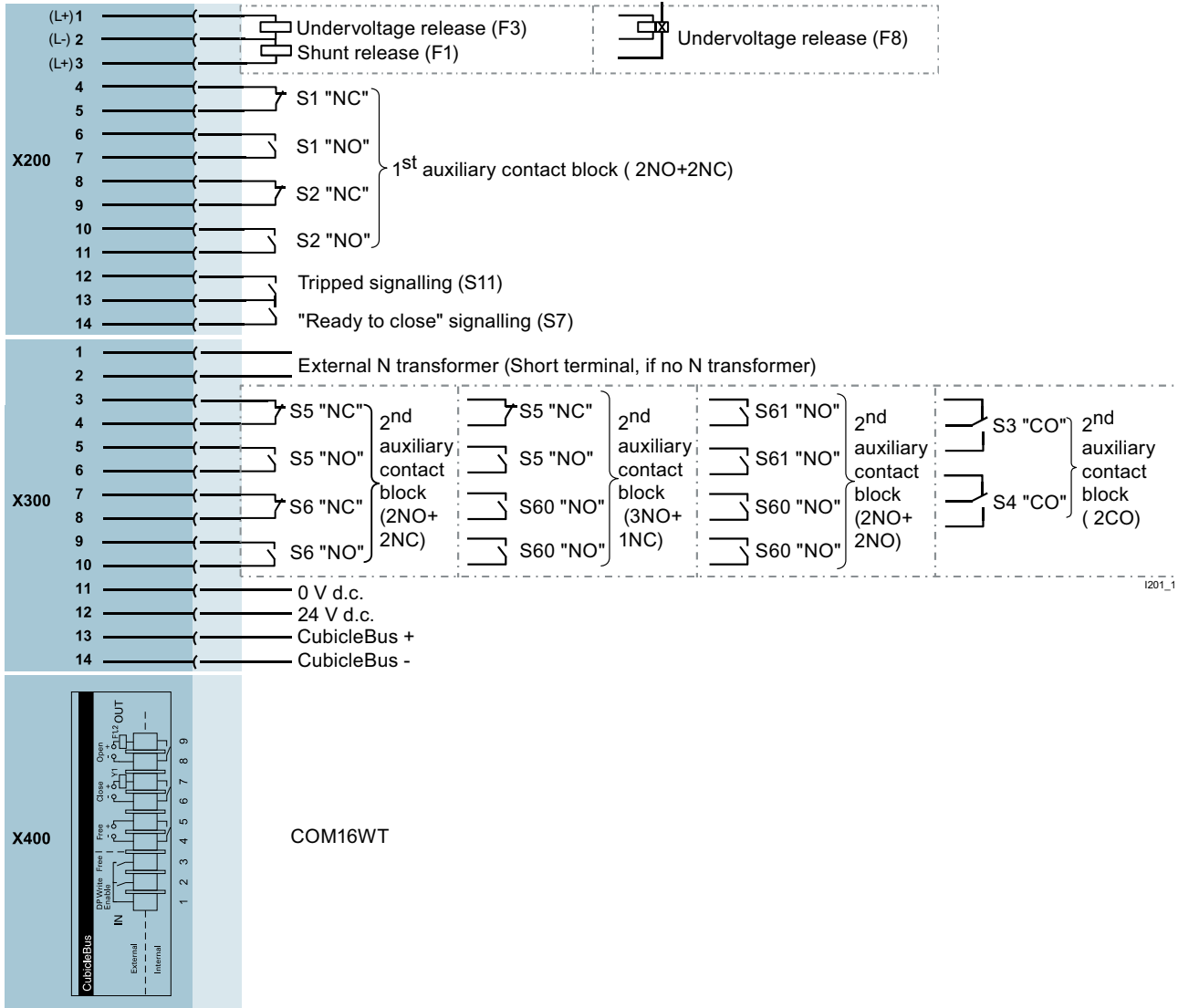

Further information

For planning guides with further descriptions relating to design, operating principle, installation and retrofitting see manual "3WT Air Circuit Breakers" at www.siemens.com/lowvoltage/manuals.

Appendix



3/2	Glossary
3/3	Catalog notes
3/4	Ordering notes
3/5	Further documentation
3/9	Standards and approvals
3/11	Siemens contacts
3/12	Service & Support
3/13	Comprehensive support from A to Z
3/14	Software licenses
3/16	Conditions of sale and delivery

Appendix

Glossary

<p>Rated operating voltage, (U_e) EN 60947-1; 4.3.1.1</p>	<p>Voltage fixed by the manufacturer. Several pertinent tests relate to its determination, as may also the utilization category. Along with the rated (operating) current, it determines the device's utilization. The highest value of rated operating voltage may in no case be greater than the value of the rate insulation voltage U_i.</p>
<p>Rated insulation voltage, (U_i) EN 60947-1; 4.3.1.2</p>	<p>Voltage measure to which are related tests of dielectric strength and creepage distance.</p>
<p>Rated current, (I_n) EN 60947-2; 4.3.2.3</p>	<p>Current value of particular circuit breaker that can be handled uninterruptedly. The highest current valued tripping the circuit breaker in conformity with a specifically stated tripping characteristic.</p>
<p>Reduced rated current, (I_r)</p>	<p>Specifically established, reduced value of I_n current for a regulated time-dependent (thermal) release and that the circuit breaker can handle continuously. Maximum setting is at value equal to I_n. Changing I_r shifts the release's tripping characteristic along the current axis. ($I_r = k \times I_n$ holds where $k \leq 1$)</p>
<p>Tripping time at a given I_r multiple, (t_r)</p>	<p>Time after which circuit breaker will trip, if a current flows through it that is equal to the given multiple of I_r. Changing t_r shifts the tripping characteristic along the time axis.</p>
<p>Actuating current of (selective) release's time-independent delay, (I_{ds})</p>	<p>Minimum current value causing the release's time-independent delay to actuate.</p>
<p>Delay of time-independent delayed release, (t_d)</p>	<p>If a current flows through the circuit breaker equal to at least I_{sd} but not reaching I_{rm} the circuit breaker will trip with time delay t_d. Total shut-off time is influenced by the tripping of the circuit breaker itself and is about $10 \div 20$ ms longer.</p>
<p>Actuating current of time-independent instantaneous, (I_{rm})</p>	<p>Minimum current value causing the time-independent instantaneous release to actuate.</p>
<p>Rated operating current, (I_e) EN 60947-1; 4.3.2.3</p>	<p>Rated operating current of device (switch-disconnector) is fixed by the manufacturer with consideration for the rated operating voltage, rated frequency, rated operation, utilization category and type of protective cover, if that comes into consideration.</p>
<p>Rated normal current, (I_u) EN 60947-1; 4.3.2.4</p>	<p>Current value set by the manufacturer and which the device can handle in continuous operation, i.e. during a period longer than 8 hours (weeks, months, or longer).</p>
<p>Rated ultimate short-circuit breaking capacity, (I_{cu}) EN 60947-2; 2.15.1; 4.3.5.2.1</p>	<p>Ultimate short-circuit breaking capacity value expressed as the rms value of the alternating component of the assumed short-circuit current that the circuit breaker must be able to manage in the mode: 1x switching off of the short circuit and a following 1x make-break sequence. After testing, the circuit breaker need not be able to conduct the rated current uninterruptedly. I_{cu} is set for the rated operating voltage at the rated frequency and at the established power factor for alternating current or at the time constant for direct current. Must fulfil the condition: $I_{cu} \geq I_k$"</p>
<p>Rated short-circuit service breaking capacity, (I_{cs}) EN 60947-2; 2.15.2; 4.3.5.2.2</p>	<p>Value of the operating short-circuit breaking capacity expressed as the rms value of the alternating component of the assumed short-circuit current that the circuit breaker must be able to manage in the mode: 1x switching off of the short circuit and a following 2x make-break sequence. May also be expressed as a percentage of I_{cu}. After testing, the circuit breaker must be able uninterruptedly to conduct the rated current and to switch off the overcurrent. Temperature increase of the main terminals may be greater. I_{cs} is set for the rated operating voltage at the rated frequency and at the established power factor for alternating current or at the time constant for direct current. Permitted: $I_{cs} \geq I_k$"</p>
<p>Rated short-time withstand current, (I_{cw}) EN 60947-1; 4.3.6.1 EN 60947-2; 4.3.5.4 EN 60947-3; 4.3.6.1</p>	<p>Value of short-time withstand current specified by the manufacturer that the device is able to handle without damage during a designated time period (short-time delay). In case of alternating current, it is the rms value of the alternating component of the assumed short-circuit current I_p.</p>

Overview

Trademarks

All product designations may be registered trademarks or product names of Siemens AG or supplier companies whose use by third parties for their own purposes may violate the rights of the owner.

Amendments

Unless stated otherwise on the individual pages of this catalog, we reserve the right to make changes, in particular to the specified values, measurements and weights.

Dimensions

All dimensions are given in mm.

Illustrations

The illustrations are not binding.

Technical specifications

The technical specifications are for general information purposes only. Always heed the operating instructions and notices on individual products during assembly, operation and maintenance.

Further technical information is available at www.siemens.com/lowvoltage/product-support

- under "Entry type":
 - Application example
 - Certificate
 - Characteristic
 - Download
 - FAQ
 - Manual
 - Product note
 - Software archive
 - Technical data



Configurators can be found at www.siemens.com/lowvoltage/configurators

Assembly, operation and maintenance

Always heed the operating instructions and notices on individual products during assembly, operation and maintenance.

Symbols

In the table below, you will find all symbols concerning connections that can occur in this catalog. In combination with orange highlighting, these identify special selection criteria.

Connections	
	Screw connection
	Ring cable lug connection
	Spring-loaded terminals

Appendix

Ordering notes

Logistics

General

With regard to delivery service, communications and environmental protection, our logistics service ensures "quality from the moment of ordering right through to delivery". By designing our infrastructure according to customer requirements and implementing electronic order processing, we have successfully optimized our logistics processes.

We are proud of our personal consulting service, on-time deliveries and one-day transport within Germany.

To this end, we supply preferred types marked with ► ex works.

We regard the ISO 9001 certification and consistent quality checks as an integral part of our services.

Electronic order processing is fast, cost-efficient and error-free. Please contact us if you want to benefit from these advantages.

Packaging, packing units

The packaging in which our equipment is dispatched provides protection against dust and mechanical damage during transport, thus ensuring that all our products arrive in perfect condition.

We select our packaging for maximum environmental compatibility and reusability (e.g. crumpled paper for protection during transport in packages up to 32 kg) and, in particular, with a view to reducing waste.

With our multi-unit and reusable packaging, we offer you specific types of packaging that are both kind to the environment and tailored to your requirements:

Your advantages at a glance:

- Lower ordering costs.
- Cost savings through same-material type packaging: Low/no disposal costs.
- Reduced time and cost thanks to short unpacking times.
- "Just-in-time" delivery directly to the production line helps reduce stock: Cost savings through reduction of storage areas.
- Fast assembly thanks to supply in sets.
- Standard Euro boxes - corresponding to the Euro pallet modular system - suitable for most conveyor systems.
- Active contribution to environmental protection.

Unless stated otherwise in the "Selection and ordering data" of this catalog, our products are supplied individually packed.

For small parts/accessories, we offer you cost-effective packaging units as standard packs containing more than one item, e.g. 5, 10, 50 or 100 units. It is essential that whole number multiples of these quantities be ordered to ensure satisfactory quality of the products and problem-free order processing.

The products are delivered in a neutral carton. The label includes warning notices, the CE marking, and device descriptions in English and German.

In addition to the Article No. (MLFB) and the number of items in the packaging, the operating instructions article number (Instr.-Order-No.) is also specified. It can be obtained from your local Siemens representative (for a list of your Siemens contacts, see www.siemens.com/lowvoltage/contact).

Most device Article No.'s can be obtained by means of the EAN barcode to simplify ordering and storage logistics.

The associated master data, too, is available from your local Siemens representative.

Low-Voltage Power Distribution and Electrical Installation Technology on the WWW

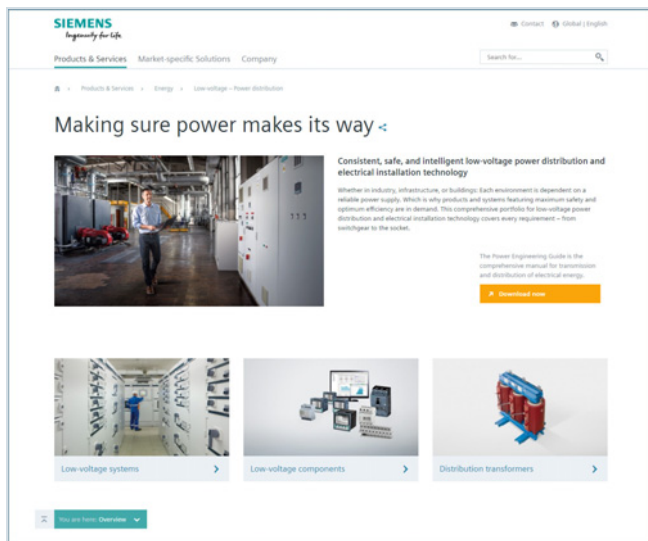

On the Internet you will find a host of information all about low-voltage power distribution and electrical installation technology products, such as:

- Overview of our product portfolio
- Background information, news and dates
- Videos, podcasts and newsletters
- Links to blogs and Twitter
- Brochures, catalogs, operating instructions and manuals for direct download

Visit us online and get to know our product range!

www.siemens.com/lowvoltage

Product selection using the interactive catalog CA 01



Detailed information together with user-friendly interactive functions

The interactive catalog CA 01 covers more than 100 000 products, thus providing a comprehensive overview of the product range provided by Siemens.

You can find everything you need here for solving automation, switching, installation and drive technology tasks. All information is provided over a user interface that is both user-friendly and intuitive.

Information about the interactive catalog CA 01 can be found on the Internet at:

www.siemens.com/automation/ca01

or on DVD.

Industry Mall

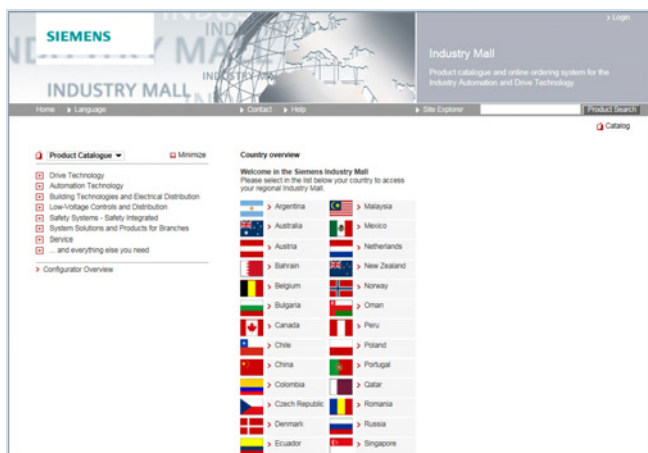

The Industry Mall – for online information, product selection and ordering

- Detailed information including product data, illustrations, certificates and CAX data
- Simple configuring of systems
- Possible to request individualized quotations
- Availability check
- Online ordering facility
- Order tracking/order overview
- Fast access to relevant training offers and services

You can find the Industry Mall on the Internet at

www.siemens.com/industrymall

Appendix

Further documentation

Industry Online Support

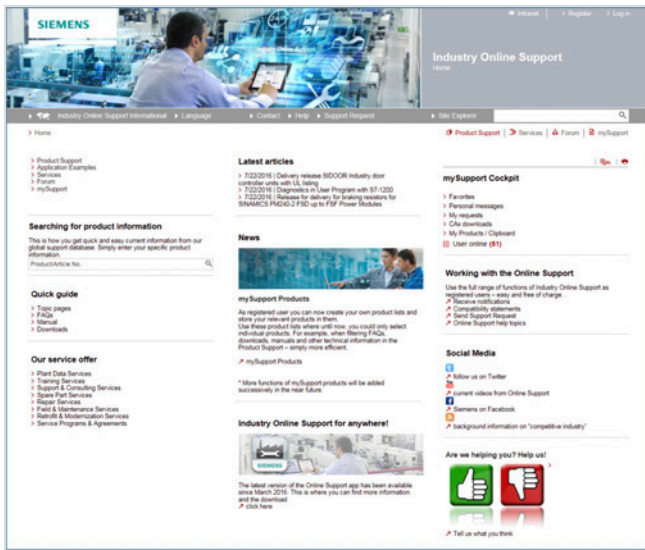

Comprehensive support – at any time, whatever your location

- FAQs, sample applications, information about successor products and product news
- Prompt assistance with technical queries
- Discussions and best practice sharing with other users in the forum
- Provision of high-quality product data for your planning programs
- Faster access to information – with helpful filter and folder functions in mySupport
- Automatic notification service to keep you up to date with the latest information about topics of interest to you

You can find Siemens Industry Online Support on the Internet at:

www.siemens.com/online-support

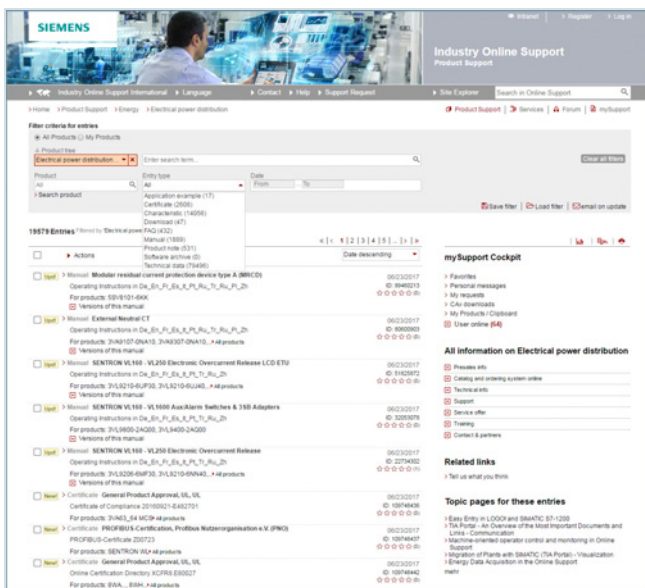

In the "Entry type" selection box in Product Support, you will find the following:

- Application example
- Certificate
- Characteristic
- Download
- FAQ
- Manual
- Product note
- Software archive
- Technical data

www.siemens.com/lowvoltage/product-support

In addition, the Low-Voltage Power Distribution and Electrical Installation Technology catalogs are also available there.

www.siemens.com/lowvoltage/catalogs

Industry Online Support App

**Main functions at a glance**

- Scanning of product codes (EAN/QR and data matrix codes) with direct display of all technical information on the product, including graphic data (CAx data).
- Delivery of product information or entries by email, so that the information can immediately be processed at the workplace.
- Submission of queries to Technical Support (Support Requests). With photo function for transmitting detailed information.
- Contents and interfaces available in 6 languages (German, English, French, Italian, Spanish and Chinese) – including option of temporary switchover to English.
- Offline cache function for all favorites stored in "mySupport". These entries can also be retrieved without network reception.
- Import of PDF documents into a library (e.g. iBooks or similar).

You can find information on the Industry Online Support App on the Internet at

<https://new.siemens.com/global/en/products/software/mobile-apps/industry-online-support.html>

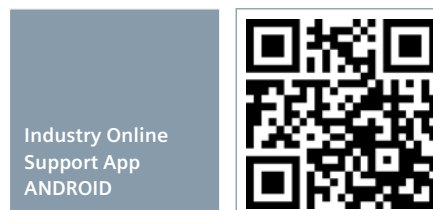
**Android:****Apple iOS:****Windows:**

Appendix

Further documentation

Product configurator

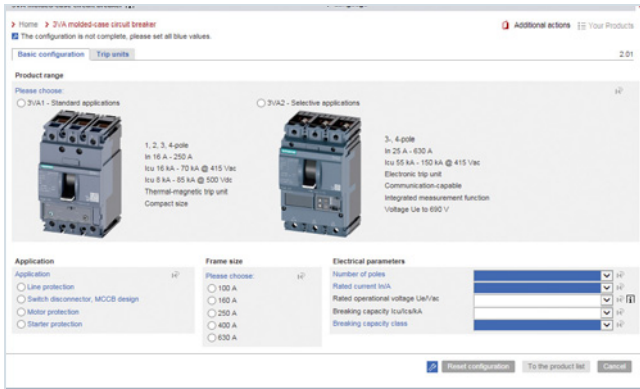

Finding the right product faster

- Complete selection of products and systems based on technical characteristics or application requirements
- Simple, intuitive operation
- Option to save the configuration and order lists in a file format of your choice (txt, pdf, xls, csv)
- Direct transfer of the order list into the shopping cart of the Siemens Industry Mall
- Fast access to product data, diagrams, certificates and CAx data for the selected product and system configuration
- Available in multiple languages for use by customers anywhere in the world

The configurators are available online in the Siemens Industry Mall and offline in Catalog CA 01.

You can find our configurators at the following website:

www.siemens.com/lowvoltage/configurators

CAx Download Manager

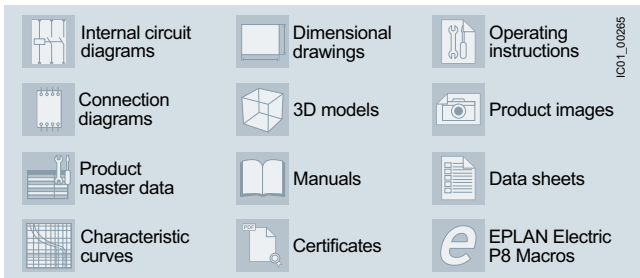

You can find the CAx Download Manager on the Internet at

www.siemens.com/lowvoltage/cax

Time savings of up to 80% with universal product data for your CAE and CAD systems

The CAx Download Manager can supply you with all the necessary CAx file types for the products of your choice for use in all common CAE and CAD systems. The data contained in the files is continuously updated. The whole process involves only four selection steps and is free of charge. All your selected files are packed into a zip file which you can download for further use.

Siemens makes available up to 12 file types to support your mechanical (CAD) and electrical (CAE) planning processes for you to download at any time of the day.

- No manual data collection necessary
- Universal manufacturer data for all common CAE and CAD systems
- Standardized documentation is simple to generate
- Choice of different languages for system commissioning anywhere in the world

My Documentation Manager

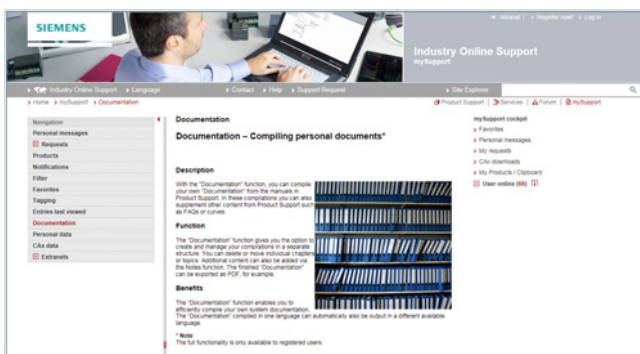

In "mySupport" you can compile individual documentation for your project by dragging and dropping

* e.g. Low Voltage Directive 2006/95/EC and EC Machinery Directive 2006/42/EC

You can find My Documentation Manager on the Internet at

www.siemens.com/lowvoltage/mdm

User-friendly compilation of project-specific documentation

In accordance with directives*, the documentation is part of the plant and requires certification, thus giving the purchaser the right to full plant documentation.

To support you in this, a manual configurator has been developed with which you can put together individual and standard-compliant documentation – fully in accordance with the relevant project-specific requirements.

You can thus select the chapters relevant to the respective project from the available manuals of the installed Siemens components. FAQs, certificates, data sheets and your own content can also be incorporated.

- Compile and structure manuals, data sheets, FAQs and certificates simply by dragging and dropping
- Insert personalized content via the Notes function
- Further processing possible thanks to selectable export formats (pdf, xml, rtf)
- After generating the documentation, automatic translation into the desired language is possible
- Always up-to-the minute thanks to the Update function

Overview

Certificates

An overview, updated on a daily basis, of our products certified in accordance with CE, UL, CSA, FM, shipping authorizations etc. for low-voltage power distribution and electrical installation products can be found on the Internet at

www.siemens.com/lowvoltage/certificates

The screenshot shows the Siemens Industry Online Support interface. The top navigation bar includes 'Intranet', 'Register', and 'Log in'. The main header is 'Industry Online Support Product Support'. Below this, there are navigation links for 'Industry Online Support International', 'Language', 'Contact', 'Help', 'Support Request', 'Site Explorer', and a search bar. The breadcrumb trail is 'Home > Product Support > Energy > Electrical Distribution'. The main content area is titled 'Filter criteria for entries' and includes options for 'All Products' and 'My Products'. The 'Product tree' is set to 'Electrical Distribution (3964)'. The 'Entry type' is set to 'Certificate (3964)'. The 'Date' field is empty. The 'Certificate type' is set to 'All', 'Approval office' is 'All', and 'Country' is 'All'. There are buttons for 'Save filter', 'Load filter', and 'email on update'. Below the filters, it shows '3964 Entries Filtered by " and 'Certificate'. The 'Entries per page' is set to 20. The list of entries includes:

Actions	Entry type	Date
<input type="checkbox"/>	Certificate UBC, CBC, IBC	06/03/2016
<input type="checkbox"/>	Certificate of Seismic Compliance 137-1000, 137-1001, 137-1002	ID: 109738005
<input type="checkbox"/>	For products: SIVACON SICUBE 8MF1 All products	☆☆☆☆☆ (0)
<input type="checkbox"/>	Certificate IEC 60980, IEC 60068-2-57	06/03/2016
<input type="checkbox"/>	Certificate of Seismic Compliance 137-1000, 137-1001, 137-1002	ID: 109738004
<input type="checkbox"/>	For products: SIVACON SICUBE 8MF1 All products	☆☆☆☆☆ (0)
<input type="checkbox"/>	Certificate General Product Approval, TSE, TSE	06/03/2016
<input type="checkbox"/>	TSE-Certificate 000082-TSE-02/01	ID: 109738035
<input type="checkbox"/>	For products: 5SL3..., 5SL6..., 5SL3...-YA, 5SL6...-YA All products	☆☆☆☆☆ (0)
<input type="checkbox"/>	Certificate General Product Approval, TSE, TSE	06/03/2016
<input type="checkbox"/>	TSE Certificate 104688-TSE-01/01	ID: 109738036
<input type="checkbox"/>	For products: 5SL3..., 5SL6..., 5SL3...-YA, 5SL6...-YA All products	☆☆☆☆☆ (0)
<input type="checkbox"/>	Certificate Declaration of Conformity, EC/EU-Declaration of Conformity, Manufacturer	06/02/2016
<input type="checkbox"/>	EU Declaration of Conformity 16047414.v01	ID: 109738003

On the right side, there is a 'mySupport Cockpit' section with links for 'Favorites', 'Personal messages', 'My requests', 'CAx downloads', 'My Products / Clipboard', and 'User online (78)'. Below that is 'All information on Electrical Distribution' with links for 'Presales info', 'Catalog and ordering system online', 'Technical info', 'Support', and 'Service offer'.

In the **Entry list**, you can **filter the view** in order to quickly find comprehensive information on the following subjects:

- Product or search term
- Date
- Type of certificate (general product approval, test certificates, shipping approval, ...)
- Certificate (confirmations, UL, VDE, ...)
- Approval office (TÜV, VDE, UL, ...)
- Country

The screenshot shows the Siemens Industry Online Support interface with the filters set to 'Electrical Distribution (323)', 'Certificate (323)', and 'VDE (323)'. The 'Country' is set to 'All'. The main content area is titled 'Filter criteria for entries' and includes options for 'All Products' and 'My Products'. The 'Product tree' is set to 'Electrical Distribution (323)'. The 'Entry type' is set to 'Certificate (323)'. The 'Date' field is empty. The 'Certificate type' is set to 'All', 'Approval office' is 'VDE (323)', and 'Country' is 'All'. There are buttons for 'Save filter', 'Load filter', and 'email on update'. Below the filters, it shows '323 Entries Filtered by " and 'Certificate' and 'VDE'. The 'Entries per page' is set to 20. The list of entries includes:

Actions	Entry type	Date
<input type="checkbox"/>	Certificate General Product Approval, VDE, VDE	06/03/2016
<input type="checkbox"/>	VDE Marks Approval 40038886	ID: 109737804
<input type="checkbox"/>	For products: 5TL1 All products	☆☆☆☆☆ (0)
<input type="checkbox"/>	Certificate General Product Approval, VDE, VDE	05/25/2016
<input type="checkbox"/>	VDE Marks Approval 40029763	ID: 109737805
<input type="checkbox"/>	For products: 5SH112 All products	☆☆☆☆☆ (0)
<input type="checkbox"/>	Certificate General Product Approval, VDE, VDE	05/25/2016
<input type="checkbox"/>	VDE Marks Approval 40029762	ID: 109737806
<input type="checkbox"/>	For products: 5SH113 All products	☆☆☆☆☆ (0)
<input type="checkbox"/>	Certificate General Product Approval, VDE, VDE	05/25/2016
<input type="checkbox"/>	VDE Marks Approval 40029716	ID: 109737808
<input type="checkbox"/>	For products: 5SH1231 All products	☆☆☆☆☆ (0)
<input type="checkbox"/>	Certificate General Product Approval, VDE, VDE	05/25/2016
<input type="checkbox"/>	VDE Marks Approval 40029715	ID: 109737807
<input type="checkbox"/>	For products: 5SH1221 All products	☆☆☆☆☆ (0)
<input type="checkbox"/>	Certificate General Product Approval, VDE, VDE	05/25/2016
<input type="checkbox"/>	VDE Marks Approval 40029715	ID: 109737807
<input type="checkbox"/>	For products: 5SH1221 All products	☆☆☆☆☆ (0)

On the right side, there is a 'mySupport Cockpit' section with links for 'Favorites', 'Personal messages', 'My requests', 'CAx downloads', 'My Products / Clipboard', and 'User online (78)'. Below that is 'All information on Electrical Distribution' with links for 'Presales info', 'Catalog and ordering system online', 'Technical info', 'Support', and 'Service offer'.

Appendix

Standards and approvals

Approval requirements valid in different countries

Siemens low-voltage switchgear and controlgear are designed, manufactured and tested according to the relevant German standards (DIN and VDE), IEC publications and European standards (EN) as well as CSA and UL standards. You will find the standards assigned to the single devices in the relevant certificates at

www.siemens.com/lowvoltage/certificates

In addition to the pertinent VDE, EN and IEC standards, the requirements of the various regulations valid in other countries have also been taken into account in the design of the equipment in some cases, in order that the devices can be deployed globally as far as possible.

In some countries an approval is required for certain low-voltage switchgear and controlgear components. Depending on the market requirements, these devices have been submitted for approval to the authorized testing institutes.

In some cases, CSA for Canada and UL for the USA only approve special versions. Such special versions are listed separately from the standard versions in the relevant parts of this catalog.

For this equipment, there are sometimes limits with regard to the maximum permissible voltages, currents and rated outputs or special approvals and, in some cases, special identification may be required.

For use on board ship, the specifications of the marine classification societies must be observed. In some cases, they require type tests of the components to be approved.

If you have any questions concerning UL/CSA approvals, please contact Technical Support:

www.siemens.com/lowvoltage/contact

Contacts for low-voltage power distribution and electrical installation technology

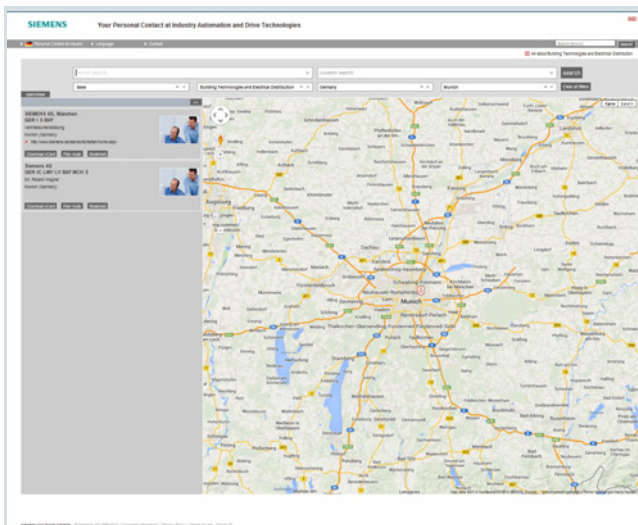
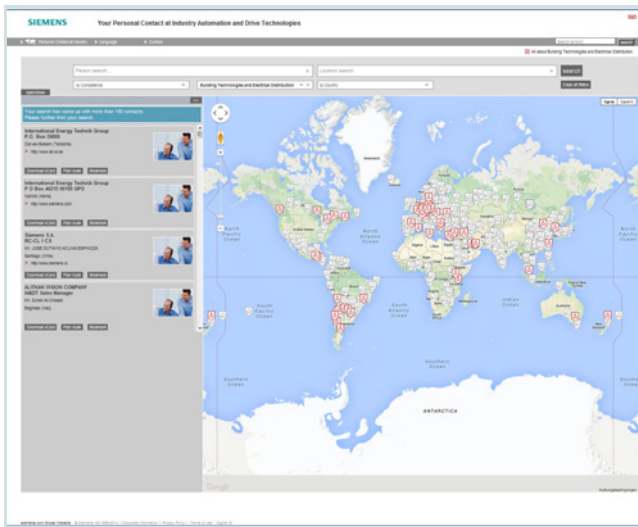

With low-voltage power distribution and electrical installation technology we consistently pursue one goal:

long-term improvement of your competitive ability.

We are committed to this goal. Thanks to our dedication, we are continually setting new standards. In all industries – worldwide.

At your service, locally, around the globe: Partners for consulting, sales, training, service, support, spare parts ... on the entire range of low-voltage power distribution and electrical installation technology.

Your personal contact can be found in our Contact Database at www.siemens.com/lowvoltage/contact

You start by selecting a

- Required competence
- Product or sector
- Country
- City

or by performing a

- search for a specific location or
- individual.

Appendix

Service & Support

Unrivalled complete range of services over the entire life cycle

Online Support



Our comprehensive online information platform covers every aspect of our Service & Support and is available whenever, wherever.

You will find further information at
www.siemens.com/online-support
www.siemens.com/lowvoltage/product-support

Field Service



Siemens Field Service offers support with all aspects of maintenance – so that the availability of your machines and plants is assured whatever the case.

You will find further information at
www.siemens.com/com/lowvoltage/contact

Technical Support



The competent consulting service for technical issues with a broad range of customer-oriented services for all our products and systems.

Assistance with technical queries is provided at
www.siemens.com/lowvoltage/support-request
 You can find your local contacts at
www.siemens.com/lowvoltage/contact

Spare Parts



Plants and systems in all industries worldwide are expected to meet ever higher levels of availability. We can help you rule out unexpected stoppages: with a global network and optimum logistics chains.

You will find further information at
www.siemens.com/lowvoltage/contact

Training



Extend your lead – with practice-related know-how straight from the manufacturer.

You will find further information at
www.siemens.com/lowvoltage/training

Specification texts

You can obtain qualified, free support to help you produce specifications for technically equipping non-residential and industrial buildings at
www.siemens.com/specifications

Overview

Product information	
Website	Fast and targeted information on low-voltage power distribution and electrical installation technology: www.siemens.com/lowvoltage
Newsletter	Always up to date about our trend-setting products and systems: www.siemens.com/lowvoltage/newsletter
Product information/product & system selection	
Siemens Industry Online Support	Low-Voltage Power Distribution and Electrical Installation Technology catalogs www.siemens.com/lowvoltage/catalogs
Industry Mall	Comprehensive information and order platform for the Siemens Industry Basket: www.siemens.com/lowvoltage/mall
CA 01	Every product for automation and drive technology, Interactive Catalog, DVD
Product and system engineering	
SIMARIS software tools	Support in planning and configuring the electrical power distribution: www.siemens.com/simaris
SIMARIS configuration software	Support throughout the entire configuration cycle from the configuration of SIVACON S8 switchboards, ALPHA distribution boards, cost calculations and quotation preparation, right through to the creation of plant documentation: www.siemens.com/simarisconfig
Software for power loss calculations - SIMARIS therm	Support in performing power loss calculations for the dimensioning of control cabinets: www.siemens.com/simaristherm
Product documentation	
Siemens Industry Online Support	Comprehensive technical information – from planning to configuration and operation: www.siemens.com/online-support www.siemens.com/lowvoltage/product-support
Product configurator	Complete selection of products and systems based on technical characteristics or application requirements: www.siemens.com/lowvoltage/configurators
CAX Download Manager	Collation of CAX data types for standard CAE and CAD systems: www.siemens.com/lowvoltage/cax
My Documentation Manager	Compilation of project-specific documentation: www.siemens.com/lowvoltage/mdm
Image database	Collection of product photographs and graphics, such as dimensional drawings and internal circuit diagrams: www.siemens.com/lowvoltage/picturedb
Product training	
SITRAIN Portal	Comprehensive training program for our products, systems and engineering tools: www.siemens.com/lowvoltage/training
Product hotline	
Technical Support	Support in all technical queries about our products: www.siemens.com/lowvoltage/support-request

Appendix

Software licenses

Overview

Software types

Software requiring a license is categorized into types. The following software types have been defined:

- Engineering software
- Runtime software

Engineering software

This includes all software products for creating (engineering) user software, e.g. for configuring, programming, parameterizing, testing, commissioning or servicing.

Data generated with engineering software and executable programs can be duplicated for your own use or for use by third-parties free-of-charge.

Runtime software

This includes all software products required for plant/machine operation, e.g. operating system, basic system, system expansions, drivers, etc.

The duplication of the runtime software and executable programs created with the runtime software for your own use or for use by third-parties is subject to a charge.

You can find information about license fees according to use in the ordering data (e.g. in the catalog). Examples of categories of use include per CPU, per installation, per channel, per instance, per axis, per control loop, per variable, etc.

Information about extended rights of use for parameterization/configuration tools supplied as integral components of the scope of delivery can be found in the readme file supplied with the relevant product(s).

License types

Siemens Industry Automation & Drive Technologies offers various types of software license:

- Floating license
- Single license
- Rental license
- Rental floating license
- Trial license
- Demo license
- Demo floating license

Floating license

The software may be installed for internal use on any number of devices by the licensee. Only the concurrent user is licensed. The concurrent user is the person using the program. Use begins when the software is started. A license is required for each concurrent user.

Single license

Unlike the floating license, a single license permits only one installation of the software per license.

The type of use licensed is specified in the ordering data and in the Certificate of License (CoL). Types of use include for example per instance, per axis, per channel, etc.

One single license is required for each type of use defined.

Rental license

A rental license supports the "sporadic use" of engineering software. Once the license key has been installed, the software can be used for a specific period of time (the operating hours do not have to be consecutive).

One license is required for each installation of the software.

Rental floating license

The rental floating license corresponds to the rental license, except that a license is not required for each installation of the software. Rather, one license is required per object (for example, user or device).

Trial license

A trial license supports "short-term use" of the software in a non-productive context, e.g. for testing and evaluation purposes. It can be transferred to another license.

Demo license

The demo license support the "sporadic use" of engineering software in a non-productive context, for example, use for testing and evaluation purposes. It can be transferred to another license. After the installation of the license key, the software can be operated for a specific period of time, whereby usage can be interrupted as often as required.

One license is required per installation of the software.

Demo floating license

The demo floating license corresponds to the demo license, except that a license is not required for each installation of the software. Rather, one license is required per object (for example, user or device).

Certificate of License (CoL)

The CoL is the licensee's proof that the use of the software has been licensed by Siemens. A CoL is required for every type of use and must be kept in a safe place.

Downgrading

The licensee is permitted to use the software or an earlier version/release of the software, provided that the licensee owns such a version/release and its use is technically feasible.

Delivery versions

Software is constantly being updated. The following delivery versions

- PowerPack
- Upgrade

can be used to access updates.

Existing bug fixes are supplied with the ServicePack version.

PowerPack

PowerPacks can be used to upgrade to more powerful software. The licensee receives a new license agreement and CoL (Certificate of License) with the PowerPack. This CoL, together with the CoL for the original product, proves that the new software is licensed.

A separate PowerPack must be purchased for each original license of the software to be replaced.

Upgrade

An upgrade permits the use of a new version of the software on the condition that a license for a previous version of the product is already held.

The licensee receives a new license agreement and CoL with the upgrade. This CoL, together with the CoL for the previous product, proves that the new version is licensed.

A separate upgrade must be purchased for each original license of the software to be upgraded.

Overview

ServicePack

ServicePacks are used to debug existing products. ServicePacks may be duplicated for use as prescribed according to the number of existing original licenses.

License key

Siemens Industry Automation & Drive Technologies supplies software products with and without license keys.

The license key serves as an electronic license stamp and is also the "switch" for activating the software (floating license, rental license, etc.).

The complete installation of software products requiring license keys includes the program to be licensed (the software) and the license key (which represents the license).

Software Update Service (SUS)

As part of the SUS contract, all software updates for the respective product are made available to you free of charge for a period of one year from the invoice date. The contract will automatically be extended for one year if it is not canceled three months before it expires.

The possession of the current version of the respective software is a basic condition for entering into an SUS contract.

You can download explanations concerning license conditions from www.siemens.com/automation/salesmaterial-as/catalog/en/terms_of_trade_en.pdf

Appendix

Conditions of sale and delivery

1. General standards

By using this catalog you can acquire hardware and software products described therein from Siemens AG subject to these conditions of sale and delivery (hereinafter: CSD). Please note: the scope, the quality and the conditions for supplies and services, including software products, by any Siemens group or Regional Company having a registered office outside of Germany, shall be subject exclusively to the General Terms and Conditions of the respective Siemens entity. These CSD apply exclusively for orders placed with Siemens AG, Germany.

1.1 For customers with a seat or registered office in Germany

For customers with a seat or registered office in Germany, the following shall be subordinate to these CSD

- for installation, the "Standard Terms and Conditions for Installation –Germany" and
- for Plant Analytics Services the "Standard Terms and Conditions for Plant Analytics Services – for Customers in Germany"¹⁾ and
- for standalone software products and software products that are part of another product or project, the "General License Conditions for Software Products for Automation and Drives for Customers with a Seat or Registered Office in Germany"¹⁾ and
- for other supplies and services, the "General Conditions for the Supply of Products and Services of the Electrical and Electronics Industry"¹⁾.
In the event that such other supplies and services include open-source software, the conditions of which override the "General Conditions for the Supply of Products and Services of the Electrical and Electronics Industry"¹⁾, the product will be supplied with a notice detailing the special conditions that apply for the relevant open-source software. This applies accordingly in the case of a reference to other third-party software components.

1.2 For customers with a seat or registered office outside of Germany

For customers with a seat or registered office outside of Germany, the following shall be subordinate to these CSD

- for Plant Analytics Services the "Standard Terms and Conditions for Plant Analytics Services"¹⁾ (only available in English) and
- for services, the "International Terms & Conditions for Services"¹⁾ supplemented by the "Software Licensing Conditions"¹⁾ and
- for the supply of other hardware and software the "International Terms & Conditions for Products"¹⁾ supplemented by the "Software Licensing Conditions"¹⁾.

1.3 For customers with framework agreements

To the extent that our products and services are covered by an existing framework agreement, the conditions there apply instead of this CSD.

2. Prices

The prices are in € (euros) ex works, excluding packaging.

The sales tax (value added tax) is not included in the prices. It shall be debited separately at the respective rate according to the applicable legal regulations.

Prices are subject to change without prior notice. We will debit the prices valid at the time of delivery.

To compensate fluctuating prices of raw materials (for example silver, copper, aluminum, lead, gold, dysprosium and neodymium), surcharges are calculated on a daily basis for products containing these raw materials using the metal factor. A surcharge for the particular raw material is added to the price of a product if the basic quotations for this raw material are exceeded.

Each product's metal factor dictates for which raw materials the metal surcharges are calculated, from which quotation and with which calculation method (weight or percentage method).

An exact explanation of the metal factor can be found at: www.siemens.com/automation/salesmaterial-as/catalog/en/terms_of_trade_en.pdf

The surcharge will be calculated (except in the case of dysprosium and neodymium) on the basis of the official price on the day prior to receipt of the order or prior to the release order for calculation of the surcharge.

In the event of placement of an order, the relevant three-month average price from the quarter prior to order receipt or the release order shall be used with a one-month buffer to calculate the dysprosium and neodymium surcharge ("rare earths") (you will find details in the aforementioned explanation of the metal factor).

3. Additional terms and conditions

All dimensions are in mm. In Germany, according to the German law on units in metrology, data in inches only apply to devices for export.

Illustrations are not binding.

Insofar as there are no remarks on the corresponding pages of this catalog - especially with regard to data, dimensions and weights given - these are subject to change without prior notice.

¹⁾ You can download the text of the Siemens AG terms and conditions of trade at www.siemens.com/automation/salesmaterial-as/catalog/en/terms_of_trade_en.pdf

4. Export regulations

We shall not be obligated to fulfill this agreement if such fulfillment is prevented by any impediments arising out of national or international foreign trade or customs requirements or any embargoes or other sanctions.

Exporting may be subject to authorization. In delivery information, we label authorization obligations according to German, European and US export lists.

Our products are controlled by the U.S. authorities (goods labeled with "ECCN" not equal to "N") and may only be supplied to the stated country of the end user for sole use by the end user. Without U.S. government approval or other approval under U.S. law, the products may not be sold, transferred or otherwise forwarded to other countries or to other persons other than the specified end user, either in their original form or after further processing into other goods. Goods labeled with an "AL" not equal to "N" are subject European/national export authorization requirements.

Please note that you can also preview the export designations in the respective product description via our "Industry Mall" online catalog system. The deciding factors, however, are the AL or ECCN export designations indicated on order confirmations, delivery notes and invoices.

Unmarked items or items marked "AL:N" / "ECCN:N" or "AL:9X9999" / "ECCN: 9X9999" may require authorization based on their intended use or ultimate destination.

If you transfer goods (hardware and/or software and/or technology as well as corresponding documentation, regardless of the mode of provision) delivered by us or works and services (including all kinds of technical support) performed by us to a third party worldwide, you shall comply with all applicable national and international (re-) export control regulations.

If required to conduct export control checks, you, at our request, shall promptly provide us with all information pertaining to particular end customers, destination and intended use of goods, works and services provided by us, as well as any relevant export control restrictions.

The products listed in this catalog may be subject to European/German and/or US export regulations. Therefore, any export requiring a license is subject to approval by the competent authorities.

Errors excepted and subject to change without prior notice.

Appendix

Notes

3

Further information can be obtained from our branch offices listed at www.siemens.com/lowvoltage/contact

Interactive Catalog	<i>Catalog</i>	Process Instrumentation and Analytics	<i>Catalog</i>
Products for Automation and Drives	CA 01	<i>Digital: Field Instruments for Process Automation</i>	FI 01
Building Control		<i>Digital: Display Recorders SIREC D</i>	MP 20
GAMMA Building Control	ET G1	<i>Digital: SIPART Controllers and Software</i>	MP 31
Drive Systems		Products for Weighing Technology	WT 10
SINAMICS G130 Drive Converter Chassis Units	D 11	<i>Digital: Process Analytical Instruments</i>	AP 01
SINAMICS G150 Drive Converter Cabinet Units		<i>Digital: Process Analytics, Components for Continuous Emission Monitoring</i>	AP 11
<i>Digital: SINAMICS PERFECT HARMONY GH180 Medium-Voltage Air-Cooled Drives (Germany Edition)</i>	D 15.1	Low-Voltage Power Distribution and Electrical Installation Technology	
SINAMICS G180 Converters – Compact Units, Cabinet Systems, Cabinet Units Air-Cooled and Liquid-Cooled	D 18.1	SENTRON · SIVACON · ALPHA	LV 10
SINAMICS S120 Chassis Format Converter Units	D 21.3	Protection, Switching, Measuring and Monitoring Devices, Switchboards and Distribution Systems	
SINAMICS S120 Cabinet Modules		Electrical Components for the Railway Industry	LV 12
SINAMICS S150 Converter Cabinet Units		Power Monitoring Made Simple	LV 14
SINAMICS S120 and SIMOTICS	D 21.4	Components for Industrial Control Panels according to UL Standards	LV 16
SINAMICS DCM DC Converter, Control Module	D 23.1	<i>Digital: Air circuit breakers and molded case circuit breakers with UL certification</i>	LV 18
SINAMICS Inverters for Single-Axis Drives · Built-In Units	D 31.1	3WT Air Circuit Breakers up to 4000 A	LV 35
SINAMICS Inverters for Single-Axis Drives · Distributed Inverters	D 31.2	3VT Molded Case Circuit Breakers up to 1600 A	LV 36
<i>Digital: SINAMICS Converters for Single-Axis Drives · SINAMICS G120X</i>	D 31.5	<i>Digital: SIVACON System Cubicles, System Lighting and System Air-Conditioning</i>	LV 50
<i>Digital: SINAMICS S210 Servo Drive System</i>	D 32	<i>Digital: ALPHA Distribution Systems</i>	LV 51
<i>Digital: SINAMICS V90 Basic Servo Drive System</i>	D 33	ALPHA FIX Terminal Blocks	LV 52
<i>Digital: SINAMICS G120P and SINAMICS G120P Cabinet pump, fan, compressor converters</i>	D 35	SIVACON S4 Power Distribution Boards	LV 56
LOHER VARIO High Voltage Motors	D 83.2	SIVACON 8PS Busbar Trunking Systems	LV 70
Flameproof, Type Series 1PS4, 1PS5, 1MV4 and 1MV5 Frame Size 355 to 1000, Power Range 80 to 7100 kW		<i>Digital: DELTA Switches and Socket Outlets</i>	ET D1
<i>Digital: Three-Phase Induction Motors SIMOTICS HV, SIMOTICS TN</i>	D 84.1	Vacuum Switching Technology and Components for Medium Voltage	HG 11.01
<i>Digital: Three-Phase Induction Motors SIMOTICS HV</i>	D 84.3	Power Supply	
High Voltage Three-phase Induction Motors	D 84.9	SITOP Power supply	KT 10.1
SIMOTICS HV Series A-compact PLUS		Safety Integrated	
<i>Digital: Modular Industrial Generators SIGENTICS M</i>	D 85.1	Safety Technology for Factory Automation	SI 10
Synchronous Motors with Permanent-Magnet Technology, HT-direct	D 86.2	SIMATIC HMI / PC-based Automation	
DC Motors	DA 12	Human Machine Interface Systems/ PC-based Automation	ST 80/ ST PC
SIMOVERT PM Modular Converter Systems	DA 45	SIMATIC Ident	
MICROMASTER 420/430/440 Inverters	DA 51.2	Industrial Identification Systems	ID 10
MICROMASTER 411/COMBIMASTER 411	DA 51.3	SIMATIC Industrial Automation Systems	
<u>Low-Voltage Three-Phase-Motors</u>		Products for Totally Integrated Automation	ST 70
SIMOTOCS S-1FG1 Servo geared motors	D 41	SIMATIC PCS 7 Process Control System	ST PCS 7
SIMOTICS Low-Voltage Motors	D 81.1	System components	
SIMOTICS FD Low-Voltage Motors	D 81.8	SIMATIC PCS 7 Process Control System	ST PCS 7 T
LOHER Low-Voltage Motors	D 83.1	Technology components	
<i>Digital: MOTOX Geared Motors</i>	D 87.1	Add-ons for the SIMATIC PCS 7 Process Control System	ST PCS 7 AO
SIMOGEAR Geared Motors	MD 50.1	SIMATIC S7-400 advanced controller	ST 400
SIMOGEAR Electric-monorail geared motors	MD 50.8	SIMATIC NET	
Light-load and heavy-load applications		Industrial Communication	IK PI
SIMOGEAR Gearboxes with adapter	MD 50.11	SIRIUS Industrial Controls	
<u>Mechanical Driving Machines</u>		<i>Digital: SIRIUS Industrial Controls</i>	IC 10
FLENDER Standard Couplings	MD 10.1		
FLENDER High Performance Couplings	MD 10.2		
FLENDER Backlash-free Couplings	MD 10.3		
FLENDER SIP Standard industrial planetary gear units	MD 31.1		
Motion Control			
SINUMERIK 840 Equipment for Machine Tools	NC 62		
SINUMERIK 808 Equipment for Machine Tools	NC 81.1		
SINUMERIK 828 Equipment for Machine Tools	NC 82		
SIMOTION Equipment for Production Machines	PM 21		
<i>Digital: Drive and Control Components for Cranes</i>	CR 1		

*Digital: These catalogs are only available as a PDF.***Siemens Industry Online Support**Digital versions of the catalogs are available on the Internet at:
www.siemens.com/lowvoltage/catalogs

Get more information

siemens.com/lowvoltage

Siemens AG
Energy Management
Low Voltage & Products
Postfach 10 09 53
93009 Regensburg
Germany

© Siemens AG 2019
Subject to change without prior notice
PDF (E86060-K1835-A101-A6-7600)
KG 0219 74 En
Produced in Germany

The information provided in this catalog contains merely general descriptions or characteristics of performance which in case of actual use do not always apply as described or which may change as a result of further development of the products. An obligation to provide the respective characteristics shall only exist if expressly agreed in the terms of contract. Availability and technical specifications are subject to change without notice.

All product designations may be trademarks or product names of Siemens AG or supplier companies whose use by third parties for their own purposes could violate the rights of the owners.

Security information

Siemens provides products and solutions with industrial security functions that support the secure operation of plants, systems, machines and networks.

In order to protect plants, systems, machines and networks against cyber threats, it is necessary to implement – and continuously maintain – a holistic, state-of-the-art industrial security concept. Siemens' products and solutions constitute one element of such a concept.

Customers are responsible for preventing unauthorized access to their plants, systems, machines and networks. Such systems, machines and components should only be connected to an enterprise network or the internet if and to the extent such a connection is necessary and only when appropriate security measures (e.g. firewalls and/or network segmentation) are in place.

For additional information on industrial security measures that may be implemented, please visit **<http://www.siemens.com/industrialsecurity>**.

Siemens' products and solutions undergo continuous development to make them more secure. Siemens strongly recommends that product updates are applied as soon as they are available and that the latest product versions are used. Use of product versions that are no longer supported, and failure to apply the latest updates may increase customer's exposure to cyber threats.

To stay informed about product updates, subscribe to the Siemens Industrial Security RSS Feed under **<http://www.siemens.com/industrialsecurity>**.